

## Ventilation Kits & Components for...

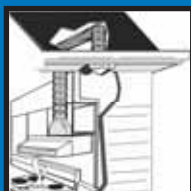

### Rangehoods

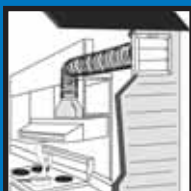
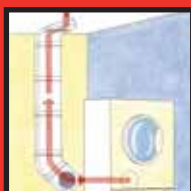
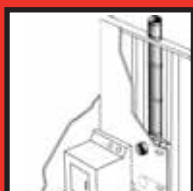

### Clothes Dryers



### Air Transfer

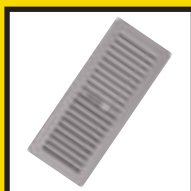

### Floor Venting



### Vents



### Ducting & Accessories

# CONTENTS

## Rangehood

Top Adaptors .....	4
Semi-Rigid Venting Kits .....	5 - 11
SUpurr-FLEX® Venting Kits .....	12 - 13
Layflat Rectangular Ducting & Components .....	14 - 15

## Clothes Dryer

DVS - In-Laundry Ducting Kits .....	16
DVS - External Ducting Kits .....	17
DVS - Individual Components .....	18 - 19
External Venting .....	20
Internal Venting .....	21
Skinny Duct Kits .....	22

## Air Transfer

Internal to External .....	23
Room to Room .....	24
In-Line Fans, Inlet & Outlet Vents .....	25



JPM International Pty Ltd  
ABN: 54 005 576 410  
21 Research Drive  
Croydon Victoria 3136  
Australia

Phone: (03) 9761 6250  
Freecall: 1800 338 574  
Facsimile: (03) 9761 6226  
Email: [info@jpmark.com.au](mailto:info@jpmark.com.au)  
Web: [www.jpmark.com.au](http://www.jpmark.com.au)

# CONTENTS

## Floor Venting

ABS Plastic - 300x100mm .....	26
Bettavent® - 300x100mm .....	27
Polycarbonate - 300x100mm .....	28
Polycarbonate - 350x150mm .....	29
Metal Registers - 300x100mm .....	30
Metal Registers - Oversized .....	31
Air Deflectors .....	32
Boots & Branch Take-Offs .....	33
Insulated Ducting .....	34

## Vents

Plastic - Wall .....	35
Stainless Steel - Wall .....	36 - 37
Under Eave .....	38 - 39
Roof .....	39
Ceiling Inlet & Outlet .....	40 - 41
Cupboard & Door Grills .....	42

## Ducting

SUppurr-FLEX® .....	43
Semi-Rigid .....	44 - 45
Insulated .....	46
Clamps .....	47
Increasesers & Elbows .....	48
Piping - "Clip Seam" .....	49
Draft Blockers .....	50
Duct Connectors .....	51

# RANGEHOOD VENTING

# TOP ADAPTORS

Have you ever wondered where all the excessive cooking by-products like fats, grease and steam go when you are using your rangehood?

Often you may find that your rangehood is being vented into the roof space - where over time - this can not only create an invitation for vermin to enter your home to feed on the cooking residues, but also greatly increase the risk and spread of fire within your home.

Elsewhere in the world - and becoming an increasing requirement here in Australia - it is legislated that appliances such as rangehoods, be vented outside to protect your greatest assets - your family and your home.

JPM have compiled a range of complete kit formats to safely expel the unwanted fumes and odours outside via 3 external methods ie... Wall, Eave and Roof.

We also pride ourselves on offering the most fire and heat resistant range of Australian approved, flexible ducting - AO Semi-Rigid aluminium ducting & SUPurr-FLEX® Multi-layered, metallic ducting.

This coupled with the many innovative external vents and component options, ensures that the likelihood of a tragedy occurring by insufficiently venting your rangehood is all but eliminated.

New to our range is the Layflat System of fire retardant, self-extinguishing, plastic ducting and components that offers a low profile, rectangular venting format for installations that have minimal space allowances.

The external dimensions of L210mm x W66mm offers greater options to vent in-between floors, wall spaces, or on the top of kitchen cabinets in a smooth, efficient manner that is less conspicuous than other forms of ducting.

Compile your own venting configuration from the many components available in the Layflat System, and use in conjunction with the external vents and accessories available from the applicable sections of this catalogue.

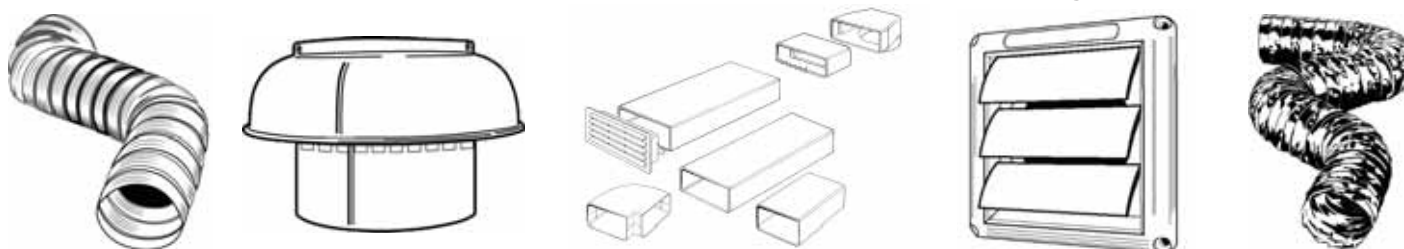

## RHF5R 125mm Round Adaptor



### Contents & Features...

Made from galvanised steel for maximum fire protection. Suits Outlets 125mm in diameter and less.

- Alcohol Wipe for surface cleaning prior to attachment
- Fire retardant/ heat resistant adhesive ring
- H50mm x Ø125mm x 13mm attachment flange



SKU	Model No.	Description	Barcode	List ea.	Pk. Qty.
	RHF5R	DEFLECTO R/HOOD FLANGE ADAPT.125MM	9317468671484	26.00	10

## RHF6R 150mm Round Adaptor



### Contents & Features...

Made from galvanised steel for maximum fire protection. Suits outlets 150mm in diameter and less.

- Alcohol Wipe for surface cleaning prior to attachment
- Fire retardant/ heat resistant adhesive ring
- H50mm x Ø150mm x 13mm attachment flange



SKU	Model No.	Description	Barcode	List ea.	Pk. Qty.
	RHF6R	DEFLECTO R/HOOD FLANGE ADAPT.150MM	9317468671491	29.00	10

## RHA5 Rectangular to Round Adaptor



### Contents & Features...

Full aluminium construction for maximum fire and corrosion protection. Suits rectangular outlets L290mm x W130mm or less.

- Alcohol Wipe for surface cleaning prior to attachment
- Fire retardant/ heat resistant adhesive strips
- H110mm x L290mm x W130mm x Ø125mm round outlet



SKU	Model No.	Description	Barcode	List ea.	Pk. Qty.
	RHA5	DEFLECTO R/HOOD ADAPTOR 290X130MM RECT-RND 125MM	9317468671477	35.00	4

# RANGEHOOD VENTING KITS

# 125mm ROOF

## Roof Mushroom Cowl Kits

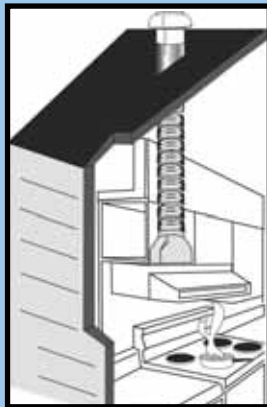

Deflect-o 125mm Roof venting kits are universal fitting and ideal for ventilation options requiring bends to navigate around obstacles within the roof cavity.

Supplied with the most efficient type of flexible ducting - Semi-Rigid aluminium ducting holds its full diameter and form when bent into shape, and also offers a superior temperature range to that of flexible foil type ducting.

Ducting expands to a straight length of 3000mm and should be extended in sections from the centre - out to each end. Refer page 44 for further details.

The Roof Mushroom Cowl is a far superior option to the common type cowl - offering greater protection from birds, rain and rust. Refer page 39 for further details.

Also available in 150mm - Refer page 9 for details



## RHK125T No - Top Adaptor

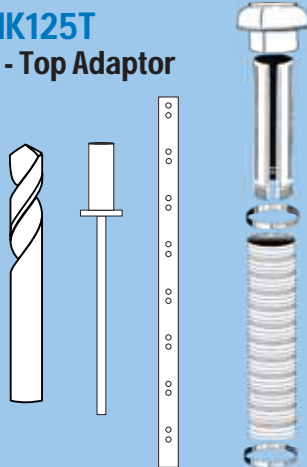

### Contents & Features...

- Roof Mushroom Cowl - aluminium
- Clip-Seam Pipe 610mm x 125mm - galvanised steel
- Bracing strap 900mm x 0.8mm - galvanised steel
- Rivets & drill bit - for attachments
- Semi-Rigid flexible duct x 3000mm - aluminium
- Metal worm drive clamps
- Overall maximum length of 3600mm
- Roof specific flashing required
- Installation by a professional is recommended



SKU	Model No.	Description	Barcode	List ea.	Pk. Qty.
	RHK125T	DEFLECTO R/HOOD 125MM SEMI-RIGID KIT - COWL	9317468658812	130.00	6

## RH125T Includes: Round Top Adaptor



### Contents & Features...

- Roof Mushroom Cowl - aluminium
- Clip-Seam Pipe 610mm x 125mm - galvanised steel
- Bracing strap 900mm x 0.8mm - galvanised steel
- Rivets & drill bit - for attachments
- Semi-Rigid flexible duct x 3000mm - aluminium
- Metal worm drive clamps
- 125mm Round Top Adaptor - galvanised steel
- Fire retardant / heat resistant adhesive ring



SKU	Model No.	Description	Barcode	List ea.	Pk. Qty.
	RH125T	DEFLECTO R/HOOD 125MM COWL KIT S/RIGID RND.ADAPT	9317468658539	155.00	6

## RHA125T Includes: Rectangle to Round Top Adaptor

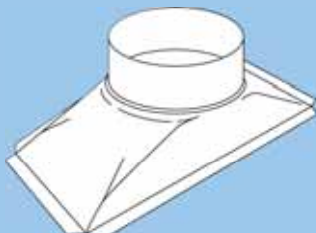

### Contents & Features...

- Roof Mushroom Cowl - aluminium
- Clip-Seam Pipe 610mm x 125mm - galvanised steel
- Bracing strap 900mm x 0.8mm - galvanised steel
- Rivets & drill bit - for attachments
- Semi-Rigid flexible duct x 3000mm - aluminium
- Metal worm drive clamps
- Rectangular to 125mm Round top adaptor - aluminium
- Fire retardant / heat resistant adhesive strips



SKU	Model No.	Description	Barcode	List ea.	Pk. Qty.
	RHA125T	DEFLECTO R/HOOD 125MM COWL KIT S/RIGID REC.ADAPT	9317468659000	159.00	6



# RANGEHOOD VENTING KITS

# 125mm ROOF

## Roof Cap Exhaust Kits

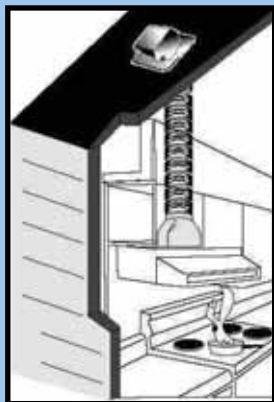

Deflect-o 125mm Roof venting kits are universal fitting and ideal for ventilation options requiring bends to navigate around obstacles within the roof cavity.

Supplied with the most efficient type of flexible ducting - Semi-Rigid aluminium ducting holds its full diameter and form when bent into shape, and also offers a superior temperature range to that of flexible foil type ducting.

Ducting expands to a straight length of 3000mm and should be extended in sections from the centre - out to each end. Refer page 44 for further details.

The Roof Cap Exhaust Vent is a low profile, black, specially formulated polypropylene vent with an internal exhaust damper. This vent offers protection from back drafts, birds, rain and rust. Refer page 39 for further details.



## RHK125R No - Top Adaptor



### Contents & Features...

- Roof cap exhaust vent
- Semi-Rigid flexible duct x 3000mm - aluminium
- Metal worm drive clamps
- Overall maximum length of 3000mm
- Remove 100mm tail piece for 125mm ducting
- Roof specific flashing required for most roof profiles
- Self flashing on slate and bitumen roofing
- Installation by a professional is recommended



SKU	Model No.	Description	Barcode	List ea.	Pk. Qty.
	RHK125R	DEFLECTO R/HOOD 125MM SEMI-RIGID KIT - ROOF	9317468658843	140.00	6

## RH125R Includes: Round Top Adaptor



### Contents & Features...

- Roof cap exhaust vent
- Semi-Rigid flexible duct x 3000mm - aluminium
- Metal worm drive clamps
- 125mm Round top adaptor - galvanised steel
- Fire retardant / heat resistant adhesive ring
- Suits round outlets 125mm and less
- Adaptor has 13mm outer flange for attachment



SKU	Model No.	Description	Barcode	List ea.	Pk. Qty.
	RH125R	DEFLECTO R/HOOD 125MM ROOF KIT S/RIGID RND.ADAPT	9317468681261	165.00	6

## RHA125R Includes: Rectangle to Round Top Adaptor

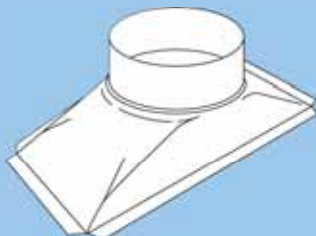

### Contents & Features...

- Roof cap exhaust vent
- Semi-Rigid flexible duct x 3000mm - aluminium
- Metal worm drive clamps
- Rectangular to 125mm Round top adaptor - aluminium
- Fire retardant / heat resistant adhesive strips
- Suits rectangular outlets 290mm x 125mm and less
- Suits 125mm round outlets for offset installations



SKU	Model No.	Description	Barcode	List ea.	Pk. Qty.
	RHA125R	DEFLECTO R/HOOD 125MM ROOF KIT S/RIGID REC.ADAPT	9317468659031	169.00	6

# RANGEHOOD VENTING KITS

# 125mm EAVE

## Eave Vent Kits



Deflect-o 125mm Eave venting kits are universal fitting and ideal for ventilation options requiring bends to navigate around obstacles within the roof cavity.

Supplied with the most efficient type of flexible ducting - Semi-Rigid aluminium ducting holds its full diameter and form when bent into shape, and also offers a superior temperature range to that of flexible foil type ducting.

Ducting expands to a straight length of 3000mm and should be extended in sections from the centre - out to each end. Refer page 44 for further details.

The Eave Vent consists of a calcium filled, polypropylene plastic with UV stabilisers.

The unique design allows air to exhaust efficiently past 2 backflow control dampers that shut when not in use.

Also available in 150mm - Refer page 10 for details.



## RHK125E No - Top Adaptor



### Contents & Features...

- Eave Vent
- Semi-Rigid flexible duct x 3000mm - aluminium
- Metal worm drive clamp

- Alternative option to roof penetration - no leaks
- Effective and unobtrusive
- Overall maximum length with bends - 2500mm
- Extend reach with additional duct, sleeve and clamps
- Installation by a professional is recommended

Hint...

- Ensure the hole cut in the Eave is set between the 2 dampers



SKU	Model No.	Description	Barcode	List ea.	Pk. Qty.
	RHK125E	DEFLECTO R/HOOD 125MM SEMI-RIGID KIT - EAVE	9317468658829	95.00	6

## RH125E Includes: Round Top Adaptor



### Contents & Features...

- Eave Vent
- Semi-Rigid flexible duct x 3000mm - aluminium
- Metal worm drive clamp
- 125mm Round top adaptor - galvanised steel
- Fire retardant / heat resistant adhesive ring

- Suits round outlets 125mm and less
- Adaptor has 13mm outer flange for attachment



SKU	Model No.	Description	Barcode	List ea.	Pk. Qty.
	RH125E	DEFLECTO R/HOOD 125MM EAVE KIT S/RIGID RND.ADAPT	9317468681254	120.00	6

## RHA125E Includes: Rectangle to Round Top Adaptor

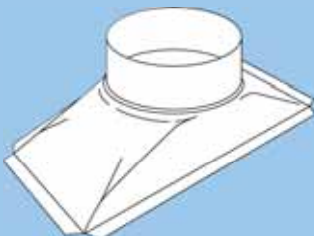

### Contents & Features...

- Eave Vent
- Semi-Rigid flexible duct x 3000mm - aluminium
- Metal worm drive clamp
- Rectangular to 125mm Round top adaptor - aluminium
- Fire retardant / heat resistant adhesive strips

- Suits rectangular outlets 290mm x 125mm and less
- Suits 125mm round outlets for offset installations



SKU	Model No.	Description	Barcode	List ea.	Pk. Qty.
	RHA125E	DEFLECTO R/HOOD 125MM EAVE KIT S/RIGID REC.ADAPT	9317468659017	125.00	6

# RANGEHOOD VENTING KITS

# 125mm WALL

## Through The Wall Kits



Deflect-o 125mm Wall venting kits are universal fitting and ideal for ventilation options requiring bends to navigate around obstacles within wall or roof cavities.

Supplied with the most efficient type of flexible ducting - Semi-Rigid aluminium ducting holds its full diameter and form when bent into shape, and also offers a superior temperature range to that of flexible foil type ducting.

Ducting expands to a straight length of 3000mm and should be extended in section from the centre - out to each end. Refer page 44 for further details.

The Wall Vent consists of a calcium filled, polypropylene plastic with UV stabilisers.

The gravity louvres allow air to exhaust, and shut to prevent the entry of back drafts, birds and vermin when not in use

Also available in 150mm - Refer page 11 for details



## RHK125W No - Top Adaptor



### Contents & Features...

- Wall Vent - plastic, gravity louvred
- Semi-Rigid flexible duct x 3000mm - aluminium
- Metal worm drive clamps

- Overall maximum length of 3000mm
- Shorten ducting length with sharp knife if required
- Extend reach with additional duct, sleeve and clamps
- Installation by a professional is recommended



SKU	Model No.	Description	Barcode	List ea.	Pk. Qty.
	RHK125W	DEFLECTO R/HOOD 125MM SEMI-RIGID KIT - WALL	9317468658836	90.00	6

## RH125W Includes: Round Top Adaptor



### Contents & Features...

- Wall Vent - plastic gravity louvred
- Semi-Rigid flexible duct x 3000mm - aluminium
- Metal worm drive clamps
- 125mm Round top adaptor - galvanised steel
- Fire retardant / heat resistant adhesive ring

- Suits round outlets 125mm and less.
- Adaptor has 13mm outer flange for attachment



SKU	Model No.	Description	Barcode	List ea.	Pk. Qty.
	RH125W	DEFLECTO R/HOOD 125MM WALL KIT S/RIGID RND.ADAPT	9317468681278	115.00	6

## RHA125W Includes: Rectangle to Round Top Adaptor

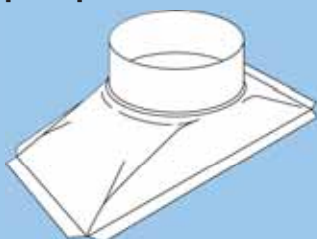

### Contents & Features...

- Wall Vent - plastic gravity louvred
- Semi-Rigid flexible duct x 3000mm - aluminium
- Metal worm drive clamps
- Rectangular to 125mm Round top adaptor - aluminium
- Fire retardant / heat resistant adhesive strips

- Suits rectangular outlets 290mm x 125mm and less
- Suits 125mm round outlets for offset installations



SKU	Model No.	Description	Barcode	List ea.	Pk. Qty.
	RHA125W	DEFLECTO R/HOOD 125MM WALL KIT S/RIGID REC.ADAPT	9317468659024	120.00	6



# RANGEHOOD VENTING KITS

# 150mm ROOF

## Roof Mushroom Cowl Kits

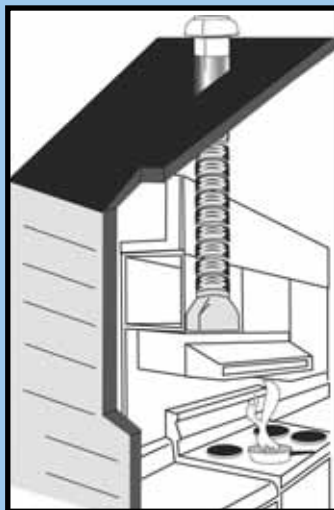

Deflect-o 150mm Roof venting kits are universal fitting and ideal for ventilation options requiring bends to navigate around obstacles within the roof cavity.

Supplied with the most efficient type of flexible ducting - Semi-Rigid aluminium ducting holds its full diameter and form when bent into shape, and also offers a superior temperature range to that of flexible foil type ducting.

Ducting expands to a straight length of 3000mm and should be extended in sections from the centre - out to each end. Refer page 44 for further details.

The Roof Mushroom Cowl is a far superior option to the common type cowl - offering greater protection from birds, rain and rust. Refer page 39 for further details.

Also available in 125mm. Refer page 5 for details

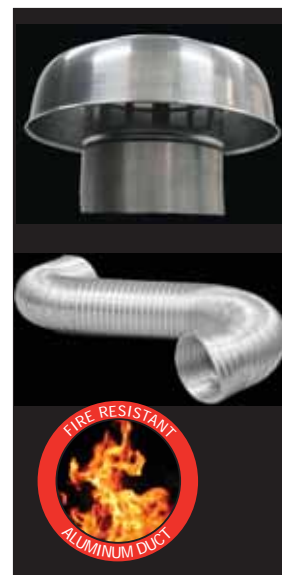

## RHK150T No - Top Adaptor

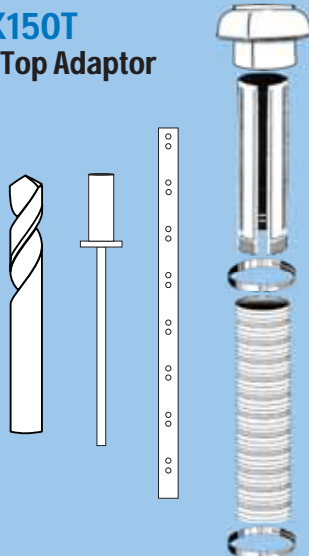

### Contents & Features...

- Roof Mushroom Cowl - aluminium
- Clip-Seam Pipe 610mm x 150mm - galvanised steel
- Bracing strap 900mm x 0.8mm - galvanised steel
- Rivets & drill bit - for attachments
- Semi-Rigid flexible duct x 3000mm - aluminium
- Metal worm drive clamps
- Overall maximum length of 3600mm
- Roof specific flashing required
- Installation by a professional is recommended



SKU	Model No.	Description	Barcode	List ea.	Pk. Qty.
	RHK150T	DEFLECTO R/HOOD 150MM SEMI-RIGID KIT - COWL	9317468658850	139.00	6

## RH150T Includes: Round Top Adaptor



### Contents & Features...

- Roof Mushroom Cowl - aluminium
- Clip-Seam Pipe 610mm x 150mm - galvanised steel
- Bracing strap 900mm x 0.8mm - galvanised steel
- Rivets & drill bit - for attachments
- Semi-Rigid flexible duct x 3000mm - aluminium
- Metal worm drive clamps
- Overall maximum length of 3600mm
- Roof specific flashing required
- Installation by a professional is recommended
- 150mm Round top adaptor - galvanised steel
- Fire retardant / heat resistant adhesive ring
- Suits round outlets 150mm and less
- Adaptor has 13mm outer flange for attachment



SKU	Model No.	Description	Barcode	List ea.	Pk. Qty.
	RH150T	DEFLECTO R/HOOD 150MM COWL KIT S/RIGID RND.ADAPT	9317468658546	165.00	6

# RANGEHOOD VENTING KITS

# 150mm EAVE

## Eave Vent Kits

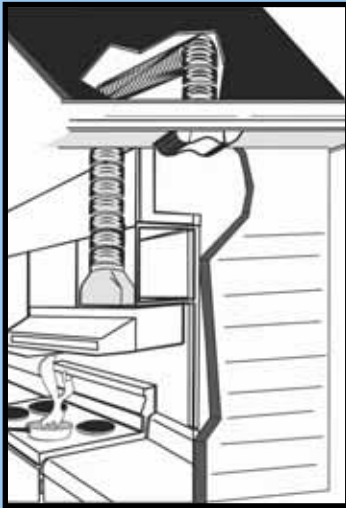

Deflect-o 150mm Eave venting kits are universal fitting and ideal for ventilation options requiring bends to navigate around obstacles within the roof cavity.

Supplied with the most efficient type of flexible ducting - Semi-Rigid aluminium ducting holds its full diameter and form when bent into shape, and also offers a superior temperature range to that of flexible foil type ducting.

Ducting expands to a straight length of 3000mm and should be extended in sections from the centre - out to each end. Refer page 44 for further details.

The Eave Vent consists of a calcium filled, polypropylene plastic with UV stabilisers.

The unique design allows air to exhaust efficiently past 2 backflow control dampers that shut when not in use.

Also available in 125mm. Refer page 7 for details

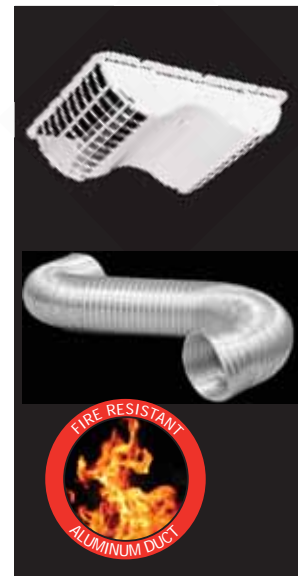

## RHK150E No - Top Adaptor

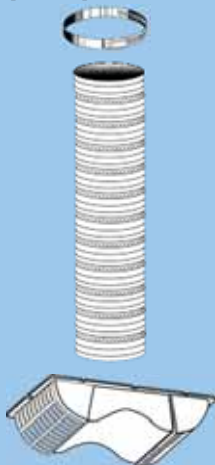

### Contents & Features...

- Eave Vent
- Semi-Rigid flexible duct x 3000mm - aluminium
- Metal worm drive clamp
- Alternative option to roof penetration - no leaks
- Effective and unobtrusive
- Overall maximum length with bends - 2500mm
- Extend reach with additional duct, sleeve and clamps
- Installation by a professional is recommended

#### Hint...

- Ensure the hole cut in the Eave is set between the 2 dampers
- For 150mm ducting, cut a rectangular hole and square-up duct



SKU	Model No.	Description	Barcode	List ea.	Pk. Qty.
	RHK150E	DEFLECTO R/HOOD 150MM SEMI-RIGID KIT - EAVE	9317468658867	105.00	6

## RH150E Includes: Round Top Adaptor



### Contents & Features...

- Eave Vent
- Semi-Rigid flexible duct x 3000mm - aluminium
- Metal worm drive clamp
- 150mm Round top adaptor - galvanised steel
- Fire retardant / heat resistant adhesive ring
- Suits round outlets 150mm and less.
- Adaptor has 13mm outer flange for attachment
- Alternative option to roof penetration - no leaks
- Effective and unobtrusive
- Overall maximum length with bends - 2500mm
- Extend reach with additional duct, sleeve and clamps
- Installation by a professional is recommended

#### Hint...

- Ensure the hole cut in the Eave is set between the 2 dampers
- For 150mm ducting, cut a rectangular hole and square-up duct



SKU	Model No.	Description	Barcode	List ea.	Pk. Qty.
	RH150E	DEFLECTO R/HOOD 150MM EAVE KIT S/RIGID RND.ADAPT	9317468658560	130.00	6

# RANGEHOOD VENTING KITS

# 150mm WALL

## Through The Wall Kits

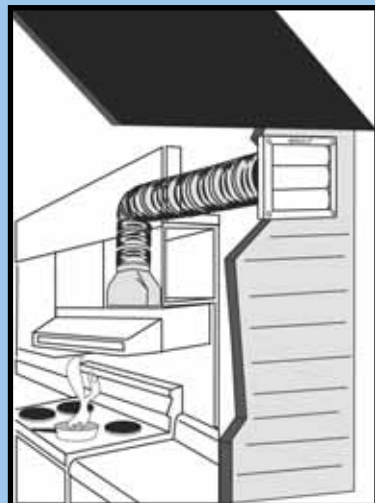

Deflect-o 150mm Wall venting kits are universal fitting and ideal for ventilation options requiring bends to navigate around obstacles within wall or roof cavities.

Supplied with the most efficient type of flexible ducting - Semi-Rigid aluminium ducting holds its full diameter and form when bent into shape, and also offers a superior temperature range to that of flexible foil type ducting.

Ducting expands to a straight length of 3000mm and should be extended in sections from the centre - out to each end. Refer page 44 for further details.

The Wall Vent consists of a calcium filled, polypropylene plastic with UV stabilisers.

The gravity louvres allow air to exhaust, and shut to prevent back-drafts, birds and vermin when not in use.

Also available in 125mm - Refer page 8 for details



## RHK150W No - Top Adaptor



### Contents & Features...

- Wall Vent - plastic, gravity louvred
- Semi-Rigid flexible duct x 3000mm - aluminium
- Metal worm drive clamps
- Overall maximum length of 3000mm
- Extend reach with additional duct, sleeve and clamps
- Installation by a professional is recommended



SKU	Model No.	Description	Barcode	List ea.	Pk. Qty.
	RHK150W	DEFLECTO R/HOOD 150MM SEMI-RIGID KIT - WALL	9317468658874	100.00	6

## RH150W Includes: Round Top Adaptor



### Contents & Features...

- Wall Vent - plastic, gravity louvred
- Semi-Rigid flexible duct x 3000mm - aluminium
- Metal worm drive clamps
- Overall maximum length of 3000mm
- Extend reach with additional duct, sleeve and clamps
- 150mm Round top adaptor - galvanised steel
- Fire retardant / heat resistant adhesive ring
- Suits round outlets 150mm and less.
- Adaptor has 13mm outer flange for attachment



SKU	Model No.	Description	Barcode	List ea.	Pk. Qty.
	RH150W	DEFLECTO R/HOOD 150MM WALL KIT S/RIGID RND.ADAPT	9317468658553	125.00	6



# RANGEHOOD VENTING

# SUpurr-FLEX® DUCT KITS

## Roof Mushroom Cowl Kits Using SUpurr-FLEX Duct



### Contents & Features...

Deflect-o SUpurr-FLEX® 125 and 150mm Roof Mushroom Cowl kits offer an economy standard, universal fitting option to vent through the roof.

SUpurr-FLEX® Multi-layered, metallic ducting has superior fire resistance and temperature ratings to our competitor's equivalents. For optimum airflow efficiency, keep ducting straight and taut.

- All kits are supplied with 3600mm x SUpurr-FLEX® Ducting

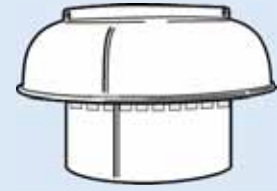

## RFK125T 125mm Roof - No Adaptor

- Roof Mushroom Cowl - aluminium
- Clip-Seam Pipe 610mm x 125mm - galvanised steel
- Metal worm drive clamps

SKU	Model No.	Description	Barcode	List ea.	Pk. Qty.
	RFK125T	DEFLECTO R/HOOD 125MM COWL KIT FLEXI DUCT	9317468661218	115.00	6

## RF125T 125mm Roof - Round Adaptor

- Roof Mushroom Cowl - aluminium
- Clip-Seam Pipe 610mm x 125mm - galvanised steel
- Round top adaptor
- Metal worm drive clamps

SKU	Model No.	Description	Barcode	List ea.	Pk. Qty.
	RF125T	DEFLECTO R/HOOD 125MM COWL KIT RND.ADAPT/FLEX	9317468661263	140.00	6

## RFA125T 125mm Roof - Rect. Adaptor

- Roof Mushroom Cowl - aluminium
- Clip-Seam Pipe 610mm x 125mm - galvanised steel
- Rectangular to Round top adaptor
- Metal worm drive clamps

SKU	Model No.	Description	Barcode	List ea.	Pk. Qty.
	RFA125T	DEFLECTO R/HOOD 125MM COWL KIT REC.ADAPT/FLEX	9317468661294	145.00	6

## RFK150T 150mm Roof - No Adaptor

- Roof Mushroom Cowl - aluminium
- Clip-Seam Pipe 610mm x 150mm - galvanised steel
- Metal worm drive clamps

SKU	Model No.	Description	Barcode	List ea.	Pk. Qty.
	RFK150T	DEFLECTO R/HOOD 150MM COWL KIT FLEXI DUCT	9317468661522	125.00	6

## RF150T 150mm Roof - Round Adaptor

- Roof Mushroom Cowl - aluminium
- Clip-Seam Pipe 610mm x 150mm - galvanised steel
- Round top adaptor
- Metal worm drive clamps

SKU	Model No.	Description	Barcode	List ea.	Pk. Qty.
	RF150T	DEFLECTO R/HOOD 150MM COWL KIT RND.ADAPT/FLEX	9317468661546	150.00	6

## Roof Exhaust Cap Kits Using SUpurr-FLEX Duct



### Contents & Features...

Deflect-o SUpurr-FLEX® 125mm Roof Cap exhaust kits offer an economy standard, universal fitting option to vent through the roof.

SUpurr-FLEX® Multi-layered, metallic ducting has superior fire resistance and temperature ratings to our competitor's equivalents.

For optimum airflow efficiency, keep ducting straight and taut.

- All kits are supplied with 3600mm x SUpurr-FLEX® Flexible Duct

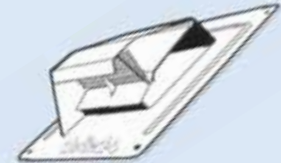

## RFK125R 125mm Roof - No Adaptor

- Roof Cap exhaust vent
- Metal worm drive clamps

SKU	Model No.	Description	Barcode	List ea.	Pk. Qty.
	RFK125R	DEFLECTO R/HOOD 125MM ROOF KIT FLEXI DUCT	9317468661232	125.00	6

## RF125R 125mm Roof - Round Adaptor

- Roof Cap exhaust vent
- Metal worm drive clamps
- Round top adaptor

SKU	Model No.	Description	Barcode	List ea.	Pk. Qty.
	RF125R	DEFLECTO R/HOOD 125MM ROOF KIT RND.ADAPT/FLEX	9317468661256	150.00	6

## RFA125R 125mm Roof - Rect. Adaptor

- Roof Cap exhaust vent
- Metal worm drive clamps
- Rectangular to Round top adaptor

SKU	Model No.	Description	Barcode	List ea.	Pk. Qty.
	RFA125R	DEFLECTO R/HOOD 125MM ROOF KIT REC.ADAPT/FLEX	9317468661287	155.00	6



# RANGEHOOD VENTING

# SUpurr-FLEX® DUCT KITS

## Eave Vent Kits Using SUpurr-FLEX Duct

### Contents & Features...

Deflect-o SUpurr-FLEX® 125 and 150mm Under-Eave kits offer an economy standard, universal fitting option to vent out through the eave.



### RFK125E 125mm Eave - No Adaptor

- Eave Vent - with 2 backflow control dampers
- SUpurr-FLEX® 125mm x 3600mm Multi-layered, metallic duct
- Metal worm drive clamps

SKU	Model No.	Description	Barcode	List ea.	Pk. Qty.
	RFK125E	DEFLECTO R/HOOD 125MM EAVE KIT FLEXI DUCT	9317468661225	85.00	6

### RF125E 125mm Eave - Round Adaptor

- Eave Vent - with 2 backflow control dampers
- SUpurr-FLEX® 125mm x 3600mm Multi-layered, metallic duct
- Round top adaptor
- Metal worm drive clamps

SKU	Model No.	Description	Barcode	List ea.	Pk. Qty.
	RF125E	DEFLECTO R/HOOD 125MM EAVE KIT RND.ADAPT/FLEX	9317468651257	110.00	6

### RFA125E 125mm Eave - Rect. Adaptor

- Eave Vent - with 2 backflow control dampers
- SUpurr-FLEX® 125mm x 3600mm Multi-layered, metallic duct
- Rectangular to Round top adaptor
- Metal worm drive clamps

SKU	Model No.	Description	Barcode	List ea.	Pk. Qty.
	RFA125E	DEFLECTO R/HOOD 125MM EAVE KIT REC.ADAPT/FLEX	9317468661270	115.00	6

### RFK150E 150mm Eave - No Adaptor

- Eave Vent - with 2 backflow control dampers
- SUpurr-FLEX® 125mm x 3600mm Multi-layered, metallic duct
- Metal worm drive clamps

SKU	Model No.	Description	Barcode	List ea.	Pk. Qty.
	RFK150E	DEFLECTO R/HOOD 150MM EAVE KIT FLEXI DUCT	9317468661515	95.00	6

### RF150E 150mm Eave - Round Adaptor

- Eave Vent - with 2 backflow control dampers
- SUpurr-FLEX® 150mm x 3600mm Multi-layered, metallic duct
- Round top adaptor
- Metal worm drive clamps

SKU	Model No.	Description	Barcode	List ea.	Pk. Qty.
	RF150E	DEFLECTO R/HOOD 150MM EAVE KIT RND.ADAPT/FLEX	9317468661539	120.00	6

## Wall Vent Kits Using SUpurr-FLEX Duct

### Contents & Features...

Deflect-o SUpurr-FLEX® 125 and 150mm gravity Wall Vent kits offer an economy standard, universal fitting option to vent out through the Wall.



### RFK125W 125mm Wall - No Adaptor

- Wall Vent - plastic, gravity louvred
- SUpurr-FLEX® 125mm x 3600mm Multi-layered, metallic duct
- Metal worm drive clamps

SKU	Model No.	Description	Barcode	List ea.	Pk. Qty.
	RFK125W	DEFLECTO R/HOOD 125MM WALL KIT FLEXI DUCT	9317468661201	80.00	6

### RF125W 125mm Wall - Round Adaptor

- Wall Vent - plastic, gravity louvred
- SUpurr-FLEX® 125mm x 3600mm Multi-layered, metallic duct
- Round top adaptor
- Metal worm drive clamps

SKU	Model No.	Description	Barcode	List ea.	Pk. Qty.
	RF125W	DEFLECTO R/HOOD 125MM WALL KIT RND.ADAPT/FLEX	9317468671255	105.00	6

### RFA125W 125mm Wall - Rect. Adaptor

- Wall Vent - plastic, gravity louvred
- SUpurr-FLEX® 125mm x 3600mm Multi-layered, metallic duct
- Rectangular to Round top adaptor
- Metal worm drive clamps

SKU	Model No.	Description	Barcode	List ea.	Pk. Qty.
	RFA125W	DEFLECTO R/HOOD 125MM WALL KIT REC.ADAPT/FLEX	9317468661300	110.00	6

### RFK150W 150mm Wall - No Adaptor

- Wall Vent - plastic, gravity louvred
- SUpurr-FLEX® 150mm x 3600mm Multi-layered, metallic duct
- Metal worm drive clamps

SKU	Model No.	Description	Barcode	List ea.	Pk. Qty.
	RFK150W	DEFLECTO R/HOOD 150MM WALL KIT FLEXI DUCT	9317468661508	90.00	6

### RF150W 150mm Wall - Round Adaptor

- Wall Vent - plastic, gravity louvred
- SUpurr-FLEX® 150mm x 3600mm Multi-layered, metallic duct
- Round top adaptor
- Metal worm drive clamps

SKU	Model No.	Description	Barcode	List ea.	Pk. Qty.
	RF150W	DEFLECTO R/HOOD 150MM WALL KIT RND.ADAPT/FLEX	9317468661553	115.00	6

# RANGEHOOD VENTING

# LAYFLAT SYSTEM

## LF20405 Layflat Channel - 0.5M



### Contents & Features...

Made from white, flame-retardant, self-extinguishing plastic.  
Suits up to 150mm Ø. Supplied flat - folds into Rectangular duct.

- W204mm x D60mm x L500mm - Volume rated to 650m<sup>3</sup> p/h.
- Convenient storage and reduced transporting costs.



SKU	Model No.	Description	Barcode	List ea.	Pk. Qty.
	LF20405	LAYFLAT SYSTEM 204 CHANNEL - 0.5M	9317468004701	10.00	10

## LF20410 Layflat Channel - 1.0M



### Contents & Features...

Made from white, flame-retardant, self-extinguishing plastic.  
Suits up to 150mm Ø. Supplied flat - folds into Rectangular duct.

- W204mm x D60mm x L500mm - Volume rated to 650m<sup>3</sup> p/h.
- Convenient storage and reduced transporting costs.

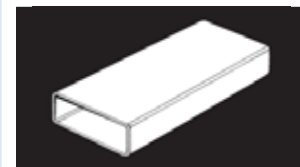

SKU	Model No.	Description	Barcode	List ea.	Pk. Qty.
	LF20410	LAYFLAT SYSTEM 204 CHANNEL - 1.0M	9317468004718	20.00	10

## VKC5605 90° Horizontal Bend



### Contents & Features...

Connects to channel duct and redirects air at a right angle.

- W204mm x D60mm - Internal dimensions
- W210mm x D66mm x L245mm - Outer dimensions

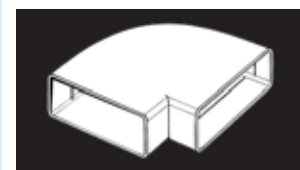

SKU	Model No.	Description	Barcode	List ea.	Pk. Qty.
	VKC5605	LAYFLAT SYSTEM 204 90° HORIZONTAL BEND	9317468004725	21.50	10

## VKC5606 Rotating Elbow Bend - 125mm



### Contents & Features...

Rotating 122mm Ø spigot for optional offset attachment of round, vertical pipe or ducting. Transition from round to rectangle.

- W204mm x D60mm x L235mm - Internal dimensions
- W210mm x D66mm x L240mm - Outer dimensions

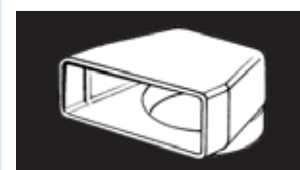

SKU	Model No.	Description	Barcode	List ea.	Pk. Qty.
	VKC5606	LAYFLAT SYSTEM 204 ROTATING ELBOW BEND - 125MM	9317468004732	19.50	10

## VKC5608 Channel Connector



### Contents & Features...

Connects 2 channel duct pieces together for extended length.

- W204mm x D60mm x L75mm - Internal dimensions
- W210mm x D66mm x L75mm - Outer dimensions



SKU	Model No.	Description	Barcode	List ea.	Pk. Qty.
	VKC5608	LAYFLAT SYSTEM 204 FLAT CHANNEL CONNECTOR	9317468004749	8.50	10

## VKC5612 90° Vertical Bend



### Contents & Features...

Connects to channel duct and redirects air at a right angle.

- W204mm x D60mm - Internal dimensions
- W210mm x D66mm x H100mm - Outer dimensions



SKU	Model No.	Description	Barcode	List ea.	Pk. Qty.
	VKC5612	LAYFLAT SYSTEM 204 90° VERTICAL BEND	9317468004756	15.00	10

## VKC5613 Round to Rectangular Adaptor



### Contents & Features...

Connects to 125mm round outlets and converts to channel duct.

- W204mm x D60mm x Ø126mm - Internal dimensions
- W210mm x D66mm x Ø132mm x H155mm - Outer dimensions



SKU	Model No.	Description	Barcode	List ea.	Pk. Qty.
	VKC5613	LAYFLAT SYSTEM 204 RND-RECT ADAPTOR	9317468004763	16.50	10

# RANGEHOOD VENTING

# LAYFLAT SYSTEM

## VKC5616 45° Horizontal Bend



### Contents & Features...

Connects to channel duct and redirects air at a 45 degree angle.

- W204mm x D60mm - Internal dimensions
- W210mm x D66mm x L225mm - Outer dimensions

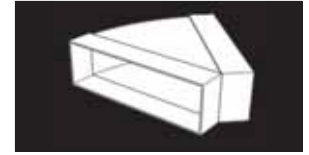

SKU	Model No.	Description	Barcode	List ea.	Pk. Qty.
	VKC5616	LAYFLAT SYSTEM 204 45° HORIZONTAL BEND	9317468004770	21.75	10

## VKC5626 Rotating Elbow Bend - 150mm



### Contents & Features...

Rotating 150mm Ø spigot for optional offset attachment of round, vertical pipe or ducting. Transition from round to rectangle.

- W204mm x D60mm x L235mm - Internal dimensions
- W210mm x D66mm x L240mm - Outer dimensions

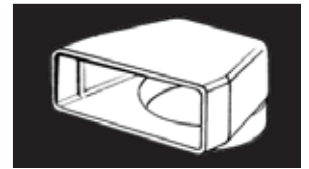

SKU	Model No.	Description	Barcode	List ea.	Pk. Qty.
	VKC5626	LAYFLAT SYSTEM 204 ROTATING ELBOW BEND - 150MM	9317468004787	19.50	10

## VKC5630 Horizontal 'T' Piece



### Contents & Features...

Connects to channel duct and redirects air L/R at a right angles .

- W204mm x D60mm - Internal dimensions
- W245mm x D66mm x L280mm - Outer dimensions

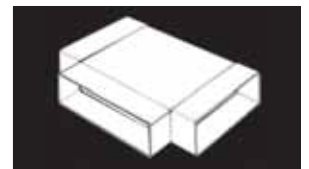

SKU	Model No.	Description	Barcode	List ea.	Pk. Qty.
	VKC5630	LAYFLAT SYSTEM 204 HORIZONTAL T PIECE	9317468004794	34.00	10

## VKC5631BE Airbrick - Beige



### Contents & Features...

Connects to channel duct as an external fixed louvred vent

- Beige in colour
- W210mm x D66mm x L65mm - Outer dimensions

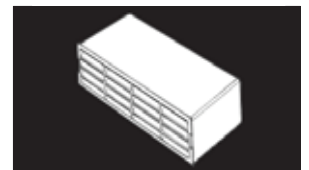

SKU	Model No.	Description	Barcode	List ea.	Pk. Qty.
	VKC5631BE	LAYFLAT SYSTEM 204 AIRBRICK - BEIGE	9317468004800	9.90	10

## VKC5631BR Airbrick - Brown

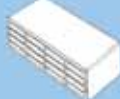

### Contents & Features...

Connects to channel duct as an external fixed louvred vent

- Chocolate Brown in colour
- W210mm x D66mm x L65mm - Outer dimensions

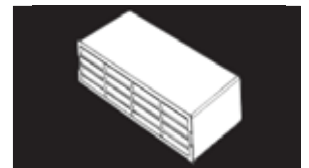

SKU	Model No.	Description	Barcode	List ea.	Pk. Qty.
	VKC5631BR	LAYFLAT SYSTEM 204 AIRBRICK - BROWN	9317468004817	9.90	10

## VKC5631T Airbrick - Terracotta Red

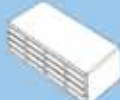

### Contents & Features...

Connects to channel duct as an external fixed louvred vent

- Terracotta Red in colour
- W210mm x D66mm x L65mm - Outer dimensions

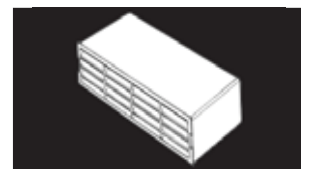

SKU	Model No.	Description	Barcode	List ea.	Pk. Qty.
	VKC5631T	LAYFLAT SYSTEM 204 AIRBRICK - TERRACOTTA	9317468004824	9.90	10

## VKC5631W Airbrick - White



### Contents & Features...

Connects to channel duct as an external fixed louvred vent

- White in colour
- W210mm x D66mm x L65mm - Outer dimensions

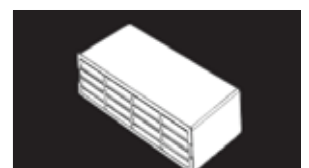

SKU	Model No.	Description	Barcode	List ea.	Pk. Qty.
	VKC5631W	LAYFLAT SYSTEM 204 AIRBRICK - WHITE	9317468004831	9.90	10



# CLOTHES DRYER VENTING

# DVS IN-LAUNDRY

## DVS2 Inlet/Outlet Kit

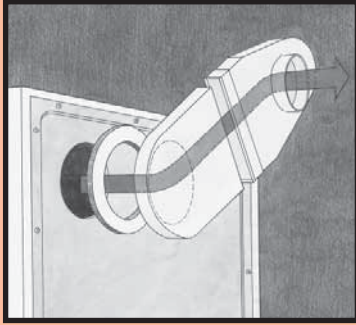

### Contents & Features...

This kit is ideal for dryers backing on to an external wall. May be extended using DVS components and vented outside using a DVS1 Through the Wall kit.

- DVSI - Low profile Inlet
- DVSWO - Low profile Wall Outlet
- DVSGR - Double sided, self adhesive gasket ring
- DVSSC - Saddle Clamp supports DVSI to rear of dryer
- DVSDT - Optional joint sealer tape
- Includes - Double sided adhesive pads for wall mount option
- Offers 360° installation option that fits under wall bracket
- Offers 275mm Inlet/Outlet centre to centre reach



SKU	Model No.	Description	Barcode	List ea.	Pk. Qty.
	DVS2	DEFLECTO DRYER VENT SYS. INLET/OUTLET KIT	9317468672146	64.50	6

## DVS3 Rectangular to Round Kit

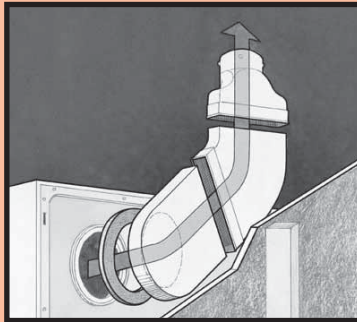

### Contents & Features...

This kit reaches the nearest edge of the dryer, where it is continued outside via flexible duct, DVSA - duct Adaptor and any DVS external ducting option.

- DVSI - Low profile Inlet
- DVSE - Low profile 45° Elbow
- DVSO - Low profile to 100mm round Outlet
- DVSGR - Double sided, self adhesive gasket ring
- DVSSC - Saddle Clamp supports DVSI to rear of dryer
- DVSDT - Optional joint sealer tape
- Includes - Double adhesive pads for wall mount option
- Dryer top, side or bottom installation option
- Offers 275mm reach from inlet centre to machine's edge



SKU	Model No.	Description	Barcode	List ea.	Pk. Qty.
	DVS3	DEFLECTO DRYER VENT SYS. RECT-100MM RND KIT	9317468672016	79.00	6

## DVS5 Corner Duct Kit

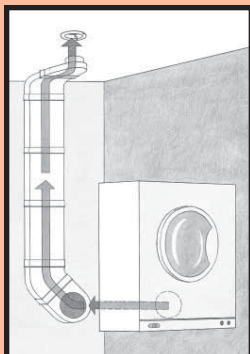
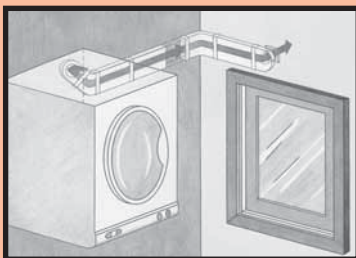

### Contents & Features...

This kit is ideal for dryers positioned on an internal wall that need to navigate around a 90° corner to ventilate outside via a secondary Wall, or Eave/ Roof via the ceiling.

Use with DVS1 - Through the Wall kit, to vent your dryer outside through an external wall.

Use with a DVS4 - Ceiling to Eave kit, to vent your dryer outside via the eave.

Use with a DVS6 - Ceiling to Roof kit to vent your dryer outside via the ceiling.

- DVSI - Low profile Inlet
- DVSE - Low profile 45° Elbow
- DVSC - Low profile 90° Internal Corner Duct
- DVSWO - Low profile Wall Outlet
- DVSD - Low profile 300mm extension Duct (x3)
- DVSGR - Double sided, self adhesive gasket ring
- DVSSC - Saddle Clamp (x4) supports ducting to wall or dryer
- DVSDT - Optional joint sealer tape
- Includes - Double adhesive pads for wall mount option
- Vertical or horizontal installation that can fit under wall bracket
- Offers 1250mm maximum reach from inlet centre to wall corner

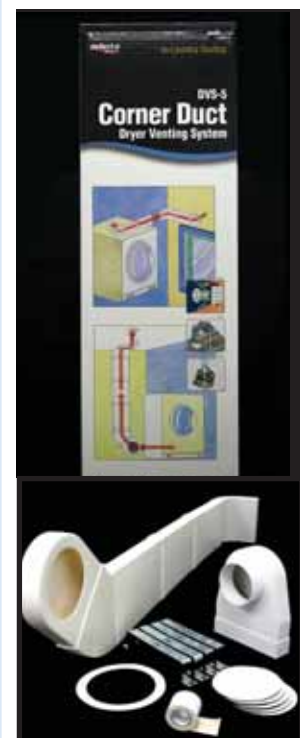

SKU	Model No.	Description	Barcode	List ea.	Pk. Qty.
	DVS5	DEFLECTO DRYER VENT SYS. CORNER DUCT KIT	9317468672160	145.00	6



# CLOTHES DRYER VENTING

# DVS EXTERNAL

## DVS1 Through The Wall Kit

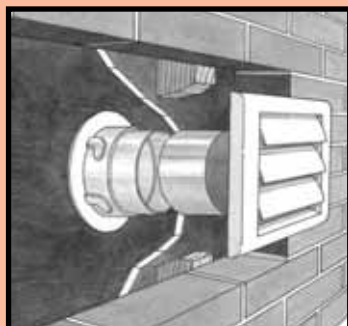

### Contents & Features...

Accepts dryer exhaust from In-Laundry ducting option and securely vents outside.  
Backflow control flaps eliminate the entry of birds and vermin.

- DVSP - Blank off Plug
- DVSWP - Low profile Wall Plate
- DP411S - 100mm x 280mm aluminium Clip-Seam Pipe
- HSR4W - Wall Vent, plastic, gravity louvred
- Ideal for new home installation as system may be plugged
- Used in conjunction with an In-Laundry ducting option
- Wall Plate accepts DVSA (flexible duct) as a turn and lock fit
- Wall Plate accepts DVSWO (low profile duct) as a push fit



SKU	Model No.	Description	Barcode	List ea.	Pk. Qty.
	DVS1	DEFLECTO DRYER VENT SYS. THRU-WALL KIT	9317468672139	46.00	6

## DVS4 Ceiling to Eave Kit

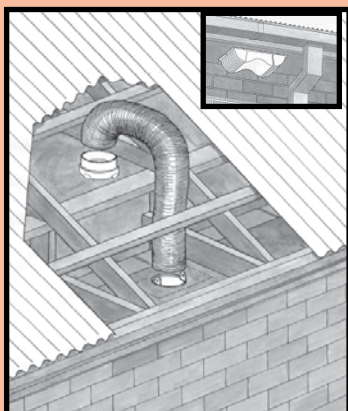

### Contents & Features...

Accepts dryer exhaust from In-Laundry ducting option and securely vents outside.  
Backflow control flaps eliminate the entry of birds and vermin.

- DVSP - Blank off Plug
- DVSWP - Low profile Wall/ceiling Plate
- MC4 - Metal worm drive clamp
- AO403MR - 3000mm Semi-Rigid aluminium ducting
- EVE - Under-Eave vent with backflow control flaps
- Ideal for new home installation as system may be plugged
- Used in conjunction with an In-Laundry ducting option
- Wall Plate accepts DVSA (flexible duct) as a turn and lock fit
- Wall Plate accepts DVSWO (low profile duct) as a push fit
- Offers 2.7 metre reach from ceiling outlet to eave



SKU	Model No.	Description	Barcode	List ea.	Pk. Qty.
	DVS4	DEFLECTO DRYER VENT SYS. CEILING-EAVE KIT	9317468672153	74.50	6

## DVS6 Ceiling to Roof Kit

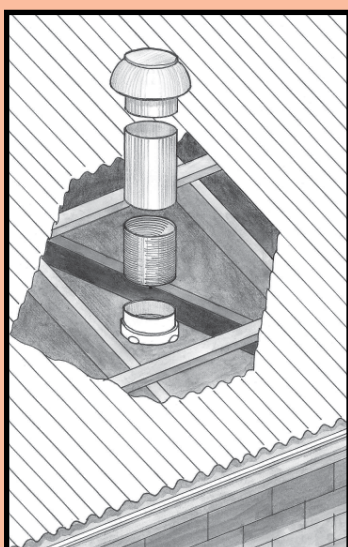

### Contents & Features...

Accepts dryer exhaust from In-Laundry ducting option and securely vents outside.  
Roof Mushroom Cowl offers protection from birds and rain.

- DVSP - Blank off Plug
- DVSWP - Low profile Wall/ceiling Plate
- MC4 - Metal worm drive clamp (x2)
- AO403MR - 3000mm Semi-Rigid aluminium ducting
- GSPX042430 - 30g. galvanised 610mm Clip-Seam Piping
- RMC4 - Roof Mushroom Cowl
- Ideal for New home installation as system may be plugged
- Used in conjunction with an In-Laundry Ducting option
- Wall Plate accepts DVSA (flexible duct) as a turn and lock fit
- Wall Plate accepts DVSWO (low profile duct) as a push fit
- Offers 3 metre reach from ceiling outlet to roof

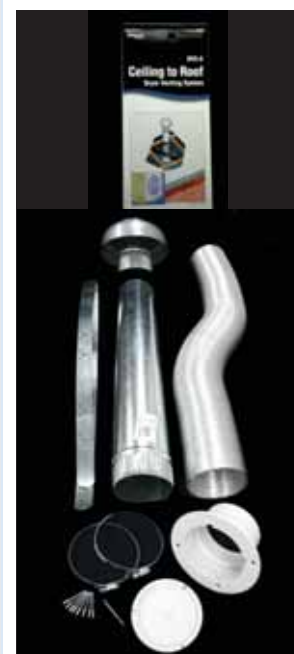

SKU	Model No.	Description	Barcode	List ea.	Pk. Qty.
	DVS6	DEFLECTO DRYER VENT SYS. CEILING-ROOF KIT	9317468672177	105.00	6

# CLOTHES DRYER VENTING

# DVS COMPONENTS

## DVSA Flexible Duct Adaptor/Connector



### Contents & Features...

Designed to connect flexible ducting into the DVSWP - Wall Plate. Turns and locks in ducting for secure attachment, or use to extend flexible ducting by clamping 2 x 100mm lengths at either end.

- Flame retardant, self-extinguishing plastic.
- Suits 100mm flexible ducting
- L75mm x 95mm Internal Ø x External 99mm Ø



SKU	Model No.	Description	Barcode	List ea.	Pk. Qty.
	DVSA	DEFLECTO DRYER VENT SYS. ADAPTOR 100MM	9317468672078	13.00	6

## DVSC Low Profile 90° Corner Duct

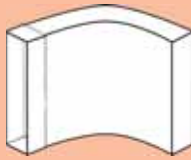

### Contents & Features...

Extends a low profile ducting system around an internal corner. Navigates air from wall to wall, or wall to ceiling.

- Flame retardant, self-extinguishing plastic.
- Lightly sand and paint to match laundry decor - optional
- Extends 160mm on either side of a corner - W195mm x D47mm



SKU	Model No.	Description	Barcode	List ea.	Pk. Qty.
	DVSC	DEFLECTO DRYER VENT SYS. CORNER DUCT	9317468672085	34.50	6

## DVSD Low Profile 300mm Extension Duct

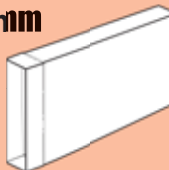

### Contents & Features...

Extends a low profile ducting system by 300mm. Designed to fit between the dryer and a standard wall mounting bracket.

- Flame retardant, self-extinguishing plastic.
- Lightly sand and paint to match laundry decor - optional
- L340mm x W195mm x D47mm



SKU	Model No.	Description	Barcode	List ea.	Pk. Qty.
	DVSD	DEFLECTO DRYER VENT SYS. DUCT 300MM EXT	9317468672047	28.00	6

## DVSE Low Profile 45° Elbow Duct



### Contents & Features...

Extends a low profile ducting system at a 45 angle. Designed to fit between the dryer and a standard wall mounting bracket.

- Flame retardant, self-extinguishing plastic.
- Lightly sand and paint to match laundry decor - optional
- L240mm x W195mm x D47mm



SKU	Model No.	Description	Barcode	List ea.	Pk. Qty.
	DVSE	DEFLECTO DRYER VENT SYS. ELBOW 45 DEG	9317468672030	28.00	6

## DVSI Low Profile Inlet Duct

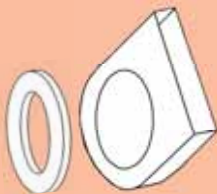

### Contents & Features...

Connects to dryers with a flush, rear outlet via an adhesive gasket to begin a rectangular ducting system that fits between the dryer and a standard wall mounting bracket.

- Flame retardant, self-extinguishing plastic.
- L235mm x W195mm x D47mm



SKU	Model No.	Description	Barcode	List ea.	Pk. Qty.
	DVSI	DEFLECTO DRYER VENT SYS. INLET DUCT	9317468672023	28.00	6

## DVSO Low Profile Transition Duct

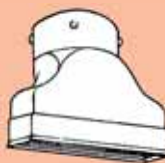

### Contents & Features...

Converts low profile ducting to a 100mm round outlet for the connection of fire rated, flexible ducting. Refer pages 43 & 44. Shaped to fit on the edge of the dryer.

- Flame retardant, self-extinguishing plastic.
- L175mm x W195mm x D47mm



SKU	Model No.	Description	Barcode	List ea.	Pk. Qty.
	DVSO	DEFLECTO DRYER VENT SYS. OUTLET 100MM	9317468672054	28.00	6

# CLOTHES DRYER VENTING

# DVS COMPONENTS

## DVSSC Saddle Clamp for Low Profile Duct

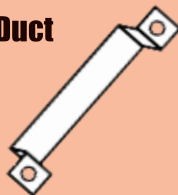

### Contents & Features...

Galvanised for corrosion protection, this Saddle Clamp helps to secure the 190mm width of the DVSI - Inlet duct to the outlet on the back of the dryer, or when DVS components are mounted on a wall or ceiling surface.

- 3 Screw slots for attachment.
- L190mm x W25mm - with 2 x 23mm Lugs on either end.



SKU	Model No.	Description	Barcode	List ea.	Pk. Qty.
	DVSSC	DVS - SADDLE CLAMP BULK	9317468672191	2.70	10

## DVSU USA Style Adaptor Cone



### Contents & Features...

When attached to a DVSI - Inlet duct, the DVSU acts as a female inlet connection to accept the dryer's exhaust from appliances with proud, rear, spigot-type outlets. Eg. Maytag, Kleenmaid etc.

- Internal cone diameter tapers from 104mm front, to 99mm rear
- 175mm Diameter - rear flange



SKU	Model No.	Description	Barcode	List ea.	Pk. Qty.
	DVSU	DEFLECTO DRYER VENT SYS. USA ADAPT. BULK	9317468672009	23.00	6

## DVSWI Low Profile Waste Inlet



### Contents & Features...

Designed to plug into dryer outlets with a 100mm internal cavity diameter to begin a rectangular ducting system. Suits late model Electrolux, Westinghouse and Simpson dryers.

- Flame retardant, self-extinguishing plastic.
- L200mm x W190mm x D43mm with 100mm x 40mm spigot



SKU	Model No.	Description	Barcode	List ea.	Pk. Qty.
	DVSWI	DEFLECTO DRYER VENT SYS. WASTE INLET	9317468672122	34.50	6

## DVSWO Low Profile Wall Outlet



### Contents & Features...

Designed to plug into the DVSWP - Wall Plate to continue outside through an External Ducting kit option - Refer page 17 40mm. Female end accepts rectangular DVS components.

- Flame retardant, self-extinguishing plastic.
- L240mm x W195mm x D47mm with 100mm x 40mm spigot.



SKU	Model No.	Description	Barcode	List ea.	Pk. Qty.
	DVSWO	DEFLECTO DRYER VENT SYS. WALL OUTLET	9317468672108	34.50	6

## DVSWP Low Profile Wall Plate



### Contents & Features...

Flush fitting Wall or Ceiling Plate, the DVSWP accepts the DVSA - Adaptor in a turn and lock fitting for flexible duct attachment, or the DVSWO - Wall Outlet when using low profile ducting.

- Supplied with removable blank-off Plug - 101mm Diameter
- Internal D40mm x 101mm Ø - 150mm Outer flange diameter



SKU	Model No.	Description	Barcode	List ea.	Pk. Qty.
	DVSWP	DEFLECTO DRYER VENT SYS. WALL PLATE/PLUG	9317468672115	34.50	6

## DV4A Diverter Assembly



### Contents & Features...

Use on rear vented dryers, where the centre of the outlet is within 160mm of the edge of the machine. Transfers into a 99mm round outlet for the attachment of fire rated, flexible ducting.

- Fits under a standard wall mounting bracket for side/top venting
- Overall length 350mm - Rectangular section 42mm x W150mm



SKU	Model No.	Description	Barcode	List ea.	Pk. Qty.
	DV4A	DEFLECTO DRYER DIVERTER ASSEMBLY	9317468671552	38.00	6



# CLOTHES DRYER VENTING

# EXTERNAL

## SVHCW4 Through The Wall Kit

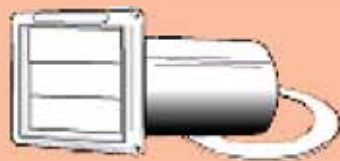

### Contents & Features...

This is a 100mm venting system designed to securely vent dryers backed directly against an external wall. Components are the tail pieces of all 100mm Wall venting kits. Suited best for base mounted dryers ie... Floor or shelf. Unlike the DVS - Dryer Venting Systems, this kit doesn't allow for hole inaccuracy - the dryer must be aligned exactly in order to connect to the outlet.

- HSR4W - Wall Vent - plastic, gravity louvred
- DP411S - 100mm x 280mm aluminium Clip-Seam Pipe
- IC4 - Internal wall Collar



SKU	Model No.	Description	Barcode	List ea.	Pk. Qty.
	SVHCW4	DEFLECTO DRYER WALL VENT PIPE KIT 100MM	079916500010	28.00	6

## SVHCW4F Through The Wall Kit with 15mm Foam Seal



### Contents & Features...

This is a 100mm venting system designed to securely vent dryers backed directly against an external wall. Includes a 15mm Foam dust seal that fits around a dryer's outlet. Suited best for base mounted Dryers ie... Floor or shelf. Unlike the DVS - Dryer Venting Systems, this kit doesn't allow for hole inaccuracy - the dryer must be aligned exactly in order to connect to the outlet.

- HSR4W - Wall Vent - plastic, gravity louvred
- DP411S - 100mm x 280mm aluminium Clip-Seam Pipe
- IC4 - Internal wall Collar
- FS4 - 15mm thick Foam dust seal



SKU	Model No.	Description	Barcode	List ea.	Pk. Qty.
	SVHCW4F	DEFLECTO DRYER WALL VENT PIPE KIT & SEAL	9137468500043	36.00	6

## SK8WF Through The Wall Kit Supurr - FLEX® Duct



### Contents & Features...

This is a 100mm venting system designed to rear vent a dryer through an outside wall via a maximum 2.4M of SUppurr-FLEX®. Suitable for dryers with a 100mm outlet flange, or combine with DVS3 or DV4A diverter kits for dryers with flush outlet hole.

- HSR4W - Wall Vent - plastic, gravity louvred
- DP411S - 100mm x 280mm aluminium Clip-Seam Pipe
- IC4 - Internal wall Collar
- FO408B - 2.4 Metres SUppurr-FLEX® metallic ducting
- CB34 - Plastic ratchet type clamps (x2)



SKU	Model No.	Description	Barcode	List ea.	Pk. Qty.
	SK8WF	DEFLECTO DRYER WALL VENT KIT & DUCT	079916500225	55.00	6

## SK8WA Through The Wall Kit Semi-Rigid Duct

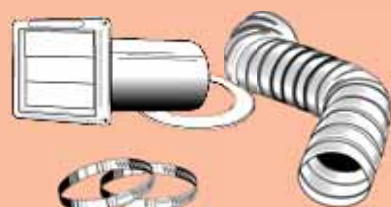

### Contents & Features...

This is a 100mm venting system designed to rear vent a dryer through an outside wall via a maximum 3 metres Semi-Rigid duct. Suitable for dryers with a 100mm outlet flange or combine with DVS3 or DV4A diverter kits for dryers with flush outlet hole.

- HSR4W - Wall Vent - plastic, gravity louvred
- DP411S - 100mm x 280mm aluminium Clip-Seam Pipe
- IC4 - Internal wall Collar
- AO403M - 3 Metres aluminium Semi-Rigid ducting
- MC4 - Metal worm drive clamps (x2)



SKU	Model No.	Description	Barcode	List ea.	Pk. Qty.
	SK8WA	DEFLECTO DRYER WALL VENT KIT SEMI RIGID DUCT	079916500157	66.00	3



# CLOTHES DRYER VENTING

# EXTERNAL & INTERNAL

## DK4W Universal Clothes Dryer Exhaust System



### Contents & Features...

Designed to rear vent a dryer through an outside wall via a max. 2.4M of SUPurr-FLEX®. Includes a rectangular to round diverter that fits under a standard wall mounting bracket for side or top venting.

Centre of the dryer's outlet must be within 160mm of the dryer's edge.

- HSR4W - Gravity louvre wall vent
- DP411S - 100mm x 280mm aluminium Clip-Seam Pipe
- IC4 - Internal wall Collar
- CB34 - Plastic ratchet type clamps (x2)
- FO408B - 2.4M SUPurr-FLEX® metallic ducting
- DV4 - Rear Diverter pipe
- DS4 - Saddle Clamp supports Divertor pipe to dryer
- GR4 - Double sided, self adhesive gasket ring



SKU	Model No.	Description	Barcode	List ea.	Pk. Qty.
	DK4W	DEFLECTO DRYER VENT KIT C/W DUCT WALL-WHITE	9317468500203	90.00	6

## LTF Lint Trap Kit

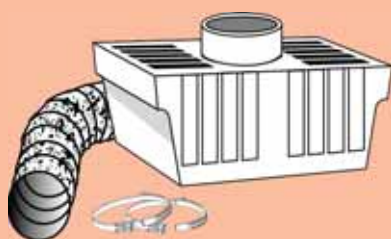

### Contents & Features...

Intended for indoor use where external venting is impractical. Fits directly on to dryers with a rear spigot-type outlet. This kit is a uniquely designed water bath trap where the fine lint that is missed by the dryer filter is collected on the water surface.

Simply fill to a 50mm depth of water and change when dirty. Suitable for dryers with a 100mm outlet flange or combine with DVS3 or DV4A diverter kits for dryers with flush outlet hole.

- Water bath Lint Trap - with removable lid
- FO4 - 1 Metre SUPurr-FLEX® metallic ducting
- CB34 - Plastic ratchet type clamps (x2)



SKU	Model No.	Description	Barcode	List ea.	Pk. Qty.
	LTF	DEFLECTO DRYER INTERN LINT TRAP C/W DUCT	079916501000	49.00	6

## LTKA Lint Trap Kit



### Contents & Features...

Complete with a rear Diverter pipe for dryers with a flush, 100mm round outlet hole, this system is intended for indoor use where external venting is impractical.

It is a uniquely designed water bath trap where the fine lint that is missed by the dryer filter is collected on the water surface. Simply fill to a 50mm depth of water and change when dirty.

- Water bath Lint Trap with removable lid
- FO4 - 1 Metre SUPurr-FLEX® metallic ducting
- CB34 - Plastic ratchet type clamps (x2)
- DV4A - Dryer Diverter kit



SKU	Model No.	Description	Barcode	List ea.	Pk. Qty.
	LTKA	DEFLECTO DRYER LINT TRAP KIT ASSEMBLY	9317468671859	89.00	6

## DB4K Dryer Outlet Flange

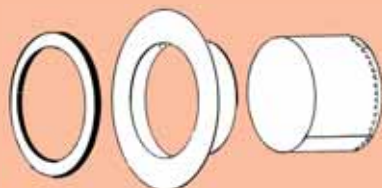

### Contents & Features...

Suited for dryers with a round, 100mm Ø outlet, this rear flange kit adheres to the back of the machine via a double sided gasket. The 100mm Ø metal flange is extended by a 75mm length of alum. clip-seam pipe that can connect into a DVSWP - Wall Plate. Alternatively - fix fire rated, flexible ducting directly on to the flange with a 100mm - metal worm drive clamp. Refer page 47

- GR4 - Double sided, self adhesive Gasket Ring
- DB4 - Galvanised metal flange adaptor 100mm Ø
- DP034 - Aluminium Clip-Seam Pipe 100mm Ø x L75mm.



SKU	Model No.	Description	Barcode	List ea.	Pk. Qty.
	DB4K	DEFLECTO DRYER BACK ADAPTOR KIT 100MM	9317468605014	00.00	6

# CLOTHES DRYER VENTING

# SKINNY DUCT

## DAIW In-Wall Skinny Duct System

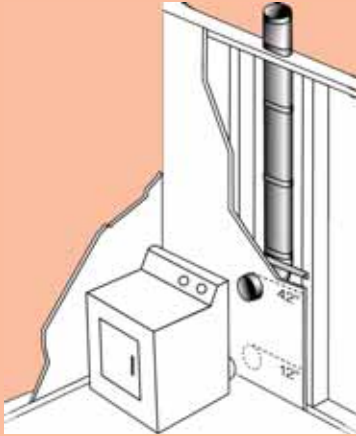

### Contents & Features...

This "Skinny Duct" system is designed to be installed inside the wall cavity of new constructions or renovations.

The oval duct fits between wall studs as a permanent venting duct that finishes as a 100mm Ø round pipe for the continuation to an external wall, eave or roof venting option.

- 90°x 100mm Ø Inlet bend to oval duct
- 3 x 800mm Oval piping lengths
- 1 x 300mm Oval piping to 100mm vertical round outlet
- Stud to stud bracing strap
- Full aluminium construction
- Fits between 75mm studs
- Maximum length up to 2.7 Metres
- Continue with fire rated, flexible ducting and external vent



SKU	Model No.	Description	Barcode	List ea.	Pk. Qty.
	DAIW	DEFLECTO DRYER VENT"SKINNY" 2700MM IN WALL	079916200415	89.90	6

## DAF2 Skinny Duct System



### Contents & Features...

This system is designed to fit between the dryer and the wall.

The oval shape of the "Skinny Duct" reduces the protrusion of the dryer within the laundry room.

Made from aluminium, it will resist the threat of corrosion and fire.

Telescopic assembly for easy length adjustment.

- 2 piece Oval piping with 100mm Ø horizontal inlet & outlets
- Adjustable length 680-1220mm
- Full aluminium construction
- Offers 360° installation option
- Continue through an outside wall with DVS1 kit.  
Refer page 17



SKU	Model No.	Description	Barcode	List ea.	Pk. Qty.
	DAF2	DEFLECTO DRYER VENT"SKINNY" 1200MM HORIZ.	079916200392	89.90	6

## DAF3 Skinny Duct System

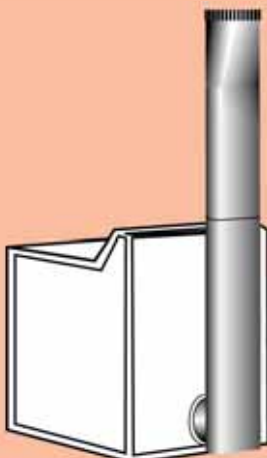

### Contents & Features...

This system is designed to fit between the dryer and the wall.

The oval shape of the "Skinny Duct" reduces the protrusion of the dryer within the laundry room.

Made from aluminium, it will resist the threat of corrosion and fire.

Telescopic assembly for easy length adjustment.

- 1 piece Oval piping with 100mm Ø horizontal inlet
- 1 piece Oval piping to 100mm Ø vertical round outlet
- Adjustable length 680-1220mm
- Full aluminium construction
- Offers 360° installation option
- Continue with fire rated, flexible ducting and external vent

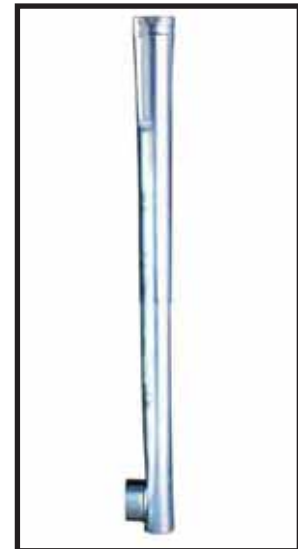

SKU	Model No.	Description	Barcode	List ea.	Pk. Qty.
	DAF3	DEFLECTO DRYER VENT"SKINNY" 1200MM VERT.	079916200446	89.90	6

# AIR TRANSFER KITS

# INTERNAL TO EXTERNAL

## Air Transfer Kits

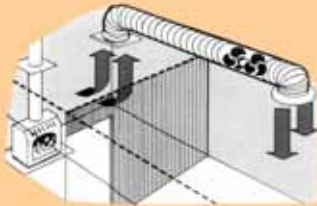
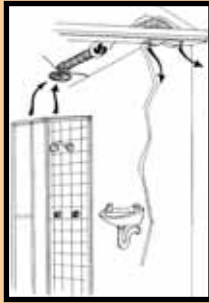

### Contents & Features...

JPM International offer several variations of Air Transfer systems that can often be the most economical way of removing or redirecting the air within your home. We pride ourselves on offering only quality components that often exceed Australian Standards.

This section of the catalogue hosts...

**Internal to External Venting kits** - designed to expel the likes of unwanted odours, moisture, smoke and vapours outside where it can no longer effect the health of home occupants and cause damage to internal fixtures and structures, resulting in expensive maintenance costs.

**Room to Room Transfer kits** - designed to transfer excessive hot or cold air from a source room, to other areas within the home requiring similar comfort levels.

This utilises an existing heat/cooling source to it's full potential and overcomes the expenses of installing separate appliances for individual rooms.

In-line fans are compatible with speed variant switches to control air volume - optional.

For additional or alternate components, please refer to either the Components pages of this category, the Vents or the Ducting & Accessories sections of this catalogue.

## LR150E

### Internal to Eave Kit

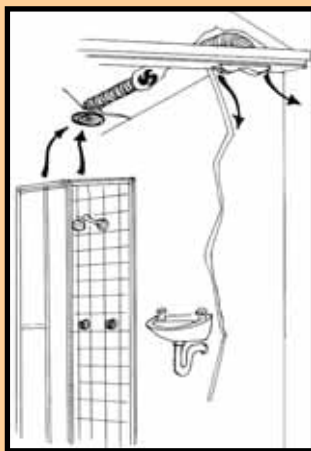

### Contents & Features...

This 150mm diameter system is designed to transfer air from one room and securely vent outside through the eave.

For use with rooms up to 30 square metres in size.

- TFG6 - 150mm Inverted cone style Ceiling Inlet
- DF150 - 150mm In-line Fan, 89 watt
- FUL0625 - 7.6M SUPurr-FLEX® metallic duct x 150mm
- EVE - Under-Eave vent with backflow control flaps
- MC6 - Metal worm drive clamps (x3)
- In-line Fan c/w 240V 3-Pin plug for instant power adaptation
- In-line Fan may be wired into a speed variant switch
- In-line Fan air volume max. 331m<sup>3</sup> per hour, 92 litres per second
- Ceiling Inlet can be closed off when not in use

SKU	Model No.	Description	Barcode	List ea.	Pk. Qty.
	LR150E	DEFLECTO 30SQM ROOM VENT KIT 150MM EAVE	9317468671897	275.00	1

## LR150W

### Internal to Wall Kit

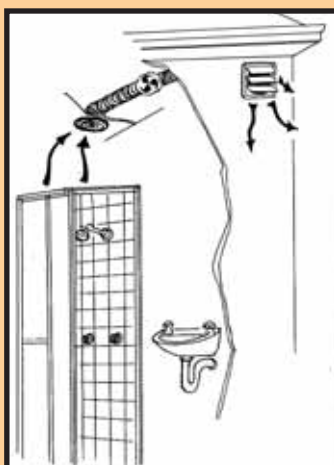

### Contents & Features...

This 150mm diameter system is designed to transfer air from one room and securely vent outside through the wall.

For use with rooms up to 30 square metres in size.

- TFG6 - 150mm Inverted cone style Ceiling Inlet
- DF150 - 150mm In-line Fan, 89 watt
- FUL0625 - 7.6M SUPurr-FLEX® metallic duct x 150mm
- HSR6W - Gravity louvred wall vent 150mm
- MC6 - Metal worm drive clamps (x4)
- In-line Fan c/w 240V 3-Pin plug for instant power adaptation
- In-line Fan may be wired into a speed variant switch
- In-line Fan air volume max. 331m<sup>3</sup> per hour, 92 litres per second
- Ceiling Inlet can be closed off when not in use

SKU	Model No.	Description	Barcode	List ea.	Pk. Qty.
	LR150W	DEFLECTO 30SQM ROOM VENT KIT 150MM WALL	9317468671903	275.00	1



# AIR TRANSFER KITS

# ROOM TO ROOM

## DIAT150

### One Room to One Room Kit Supurr-FLEX® Ducting to 11m.

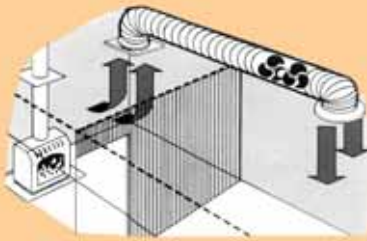

### Contents & Features...

Whilst the ducting in this kit doesn't come wrapped in insulation, SUPurr-FLEX® is a Multi-Ply, foil type, metallic ducting that offers superior protection against fire, whilst still giving some insulation benefits.

- TFG6 - 150mm Inverted cone style Ceiling Inlet
- DJ150 - 150mm DownJet Ceiling Outlet
- FUL0625 - 7.6M SUPurr-FLEX® metallic duct x 150mm
- FO603M - 3.6M SUPurr-FLEX® metallic duct x 150mm
- DF150 - 150mm In-line Fan, 89watt
- MC6 - Metal worm drive clamps (x4)



Please refer to page 25 for further information on In-line fans.

SKU	Model No.	Description	Barcode	List ea.	Pk. Qty.
	DIAT150	DEFLECTO 1-1 ROOM AIR TRANSFER KIT 150MM	9317468671798	325.00	1

## DIAT150I

### One Room to One Room Kit \*Fully Insulated Ducting to 9m.

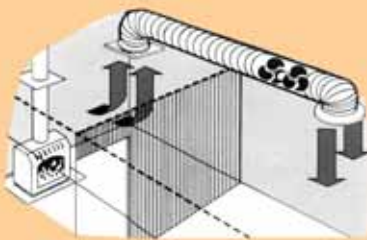

### Contents & Features...

This 150mm diameter system is designed to transfer air/ heat from one room to another room up to 9 metres away using fully Insulated ducting.

- TFG6 - 150mm Inverted cone style Ceiling Inlet
- DJ150 - 150mm DownJet Ceiling Outlet
- D603M - 3 Metre Insulated duct x 150mm
- D606M - 6 Metre Insulated duct x 150mm
- DF150 - In-line Fan, 89 watt
- MC6 - Metal worm drive clamps (x4)



Please refer to page 25 for further information on In-line fans.

SKU	Model No.	Description	Barcode	List ea.	Pk. Qty.
	DIAT150I	DEFLECTO 1-1ROOM AIR TRANSFER INSUL 150MM	9317468671804	350.00	1

## DIAT200

### One Room to Two Rooms Kit Supurr-FLEX® Ducting to 11m.

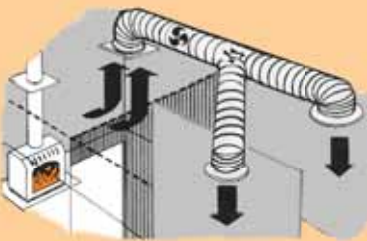

### Contents & Features...

This 200mm to 150mm split diameter system is designed to transfer air/ heat from one room to another two rooms up to 11 metres away using multiply, foil type - SUPurr-FLEX® metallic ducting.

- CD200 - 200mm Inverted cone style Ceiling Inlet
- DJ150 - 150mm DownJet Ceiling Outlet (x2)
- FO803M - 3.6M SUPurr-FLEX® metallic duct x 200mm
- FUL0625 - 7.6M SUPurr-FLEX® metallic duct x 150mm (x2)
- DF200 - 200mm In-line Fan, 98 watt
- DY866 - 200x150x150mm Plastic Y branch
- MC6 - 150mm Metal Clamps (x4) • MC8 - 200mm Metal Clamps (x4)



Please refer to page 25 for further information on In-line fans.

SKU	Model No.	Description	Barcode	List ea.	Pk. Qty.
	DIAT200	DEFLECTO 1-2 ROOM AIR TRANSFER KIT 200MM	9317468671781	510.00	1

## DIAT200I

### One Room to Two Rooms Kit \*Fully Insulated Ducting to 9m.

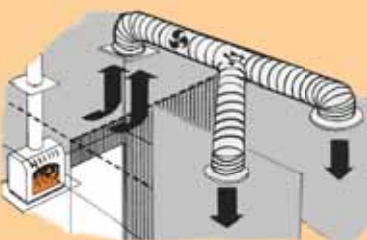

### Contents & Features...

This 200mm to 150mm split diameter system is designed to transfer air/ heat from one room to another two rooms up to 9 metres away using fully Insulated ducting.

- CD200 - 200mm Inverted Cone style Ceiling Inlet
- DJ150 - 150mm DownJet Ceiling Outlet (x2)
- D803M - 3 Metre Insulated duct x 200mm
- D606M - 6 Metre Insulated duct x 150mm (x2)
- DF200 - 200mm In-line Fan, 98 watt
- DY866 - 200x150x150mm Plastic Y branch
- MC6 - 150mm Metal Clamps (x4) • MC8 - 200mm Metal Clamps (x4)



Please refer to page 25 for further information on In-Line fans.

SKU	Model No.	Description	Barcode	List ea.	Pk. Qty.
	DIAT200I	DEFLECTO 1-2ROOM AIR TRANSFER INSUL 200MM	9317468671750	550.00	1



## Inline Fans



### Contents & Features...

The Deflect-o range of In-line Fans have been specifically designed to provide maximum airflow while maintaining quiet operation. The fan is housed in a quality, solid body to ensure stability and long term reliable operation. Mounting holes are provided where solid mounting is required.

The fans use a shaded pole induction motor and are supplied with a standard 240V - three pin plug. If applicable, the fans can be used with a fan controller switch to allow for variable speed control.

### DF150 150mm In-Line Fan

- Suits 150mm Ducting
- 89 Watt
- 331m3/h
- 92 Litres/Second

SKU	Model No.	Description	Barcode	List ea.	Pk. Qty.
	DF150	DEFLECTO IN-LINE FAN 338M3/H - 150MM	9317468641500	199.00	3

### DF200 200mm In-Line Fan

- Suits 200mm Ducting
- 98 Watt
- 486m3/h
- 135 Litres/Second

SKU	Model No.	Description	Barcode	List ea.	Pk. Qty.
	DF200	DEFLECTO IN-LINE FAN 486M3/H - 200MM	9317468642002	265.00	3

### DF250 250mm In-Line Fan

- Suits 250mm Ducting
- 154 Watt
- 727m3/h
- 202 Litres/Second

SKU	Model No.	Description	Barcode	List ea.	Pk. Qty.
	DF250	DEFLECTO IN-LINE FAN 727M3/H - 250MM	9317468642507	299.00	3

## Ceiling Diffuser - Inlets



### Contents & Features...

Commonly used for air intake, the design of these Ceiling Diffusers accepts air from surrounding surfaces and not directly below. This makes it ideal for heat, smoke and vapour extraction/ transfer.

Adjustable closure by simply screwing the inverted cone centre. Easy to install and remove for cleaning.



### TFG6 150mm Inlet Ceiling Diffuser

- Suits 150mm Diameter Duct
- 200mm Outer Diameter
- White - Plastic
- Adjustable Closure

SKU	Model No.	Description	Barcode	List ea.	Pk. Qty.
	TFG6	DEFLECTO CEILING DIFFUSER/INTAKE 150MM	079916934216	24.00	6

### CD200 200mm Inlet Ceiling Diffuser

- Suits 200mm Ducting
- 320mm Outer Diameter
- White - Plastic
- Adjustable Closure

SKU	Model No.	Description	Barcode	List ea.	Pk. Qty.
	CD200	DEFLECTO CEILING DIFFUSER/INTAKE 200MM	9317468671736	48.50	6

## Ceiling Diffuser - Outlets



### Contents & Features...

This range of DownJet Ceiling Diffusers evenly disperses air to a chosen area. Simple to install, it comes with spring loaded attachment arms that lock and secure the vent in place.

Adjustable closure by pushing in and turning the central control knob to activate the internal butterfly damper.



### DJ150 150mm Outlet Ceiling Diffuser

- Suits 150mm Ducting
- 240mm Outer Diameter
- White - Plastic
- Adjustable Closure

SKU	Model No.	Description	Barcode	List ea.	Pk. Qty.
	DJ150	DEFLECT-O 150mm DOWNJET OUTLET	9317468681100	30.00	6

### DJ200 200mm Outlet Ceiling Diffuser

- Suits 200mm Ducting
- 290mm Outer Diameter
- White - Plastic
- Adjustable Closure

SKU	Model No.	Description	Barcode	List ea.	Pk. Qty.
	DJ200	DEFLECT-O 200mm DOWNJET OUTLET	9317468681117	39.00	6

# FLOOR VENTS

# ABS PLASTIC 300x100mm

## ABS Plastic Vents 300 x 100mm (12" x 4")



### Contents & Features...

The Deflect-o® range of ABS plastic floor vents feature the latest design with a sleek modern look, rounded corners and wider vent blades. These floor vents have a smooth, fully closing damper operation with flush button control mechanism.

- Super high strength - compared to polycarbonate vents
- Maintenance and Rust free
- Dishwasher safe
- 12 Attractive designer colours
- 5 Year replacement warranty

\*Hint - To deflect air across the floor use Model 50 or 99 Air Deflectors - Refer page 32

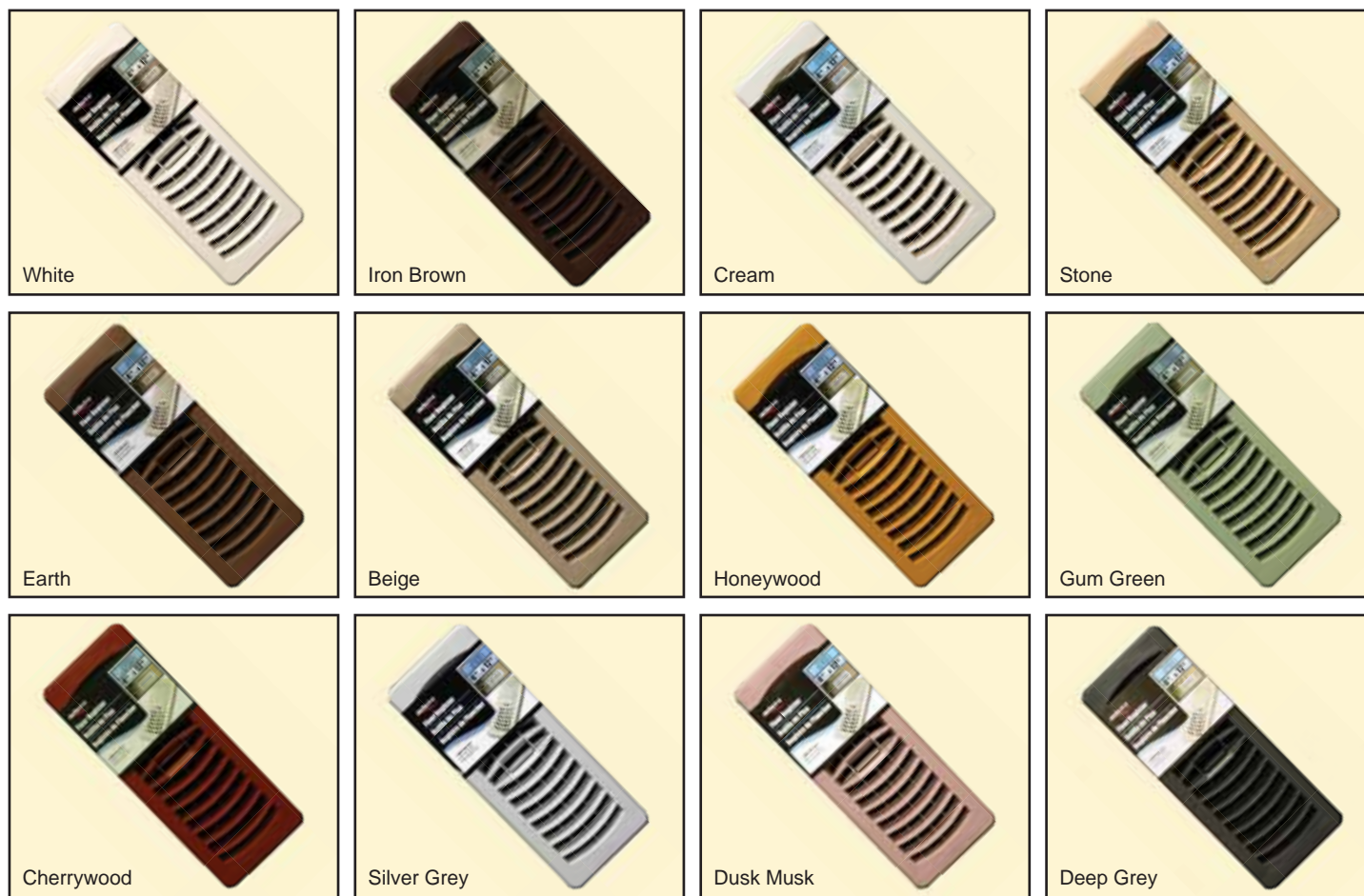

SKU	Model No.	Description	Barcode	List ea.	Pk. Qty.
	RF41203	DEFLECTO 12x4" FLOOR VENT ABS - WHITE	079916201733	11.10	10
	RF41213	DEFLECTO 12x4" FLOOR VENT ABS - IRON BROWN	079916212135	11.10	10
	RF41217	DEFLECTO 12x4" FLOOR VENT ABS - CREAM	079916212173	11.10	10
	RF41218	DEFLECTO 12x4" FLOOR VENT ABS - STONE	079916212180	11.10	10
	RF41226	DEFLECTO 12x4" FLOOR VENT ABS - EARTH	079916212265	11.10	10
	RF41228	DEFLECTO 12x4" FLOOR VENT ABS - BEIGE	079916201771	11.10	10
	RF41239	DEFLECTO 12x4" FLOOR VENT ABS - HONEYWOOD	079916212395	11.10	10
	RF41244	DEFLECTO 12x4" FLOOR VENT ABS - GUM GREEN	079916212449	11.10	10
	RF41249	DEFLECTO 12x4" FLOOR VENT ABS - CHERRYWOOD	079916212494	11.10	10
	RF41253	DEFLECTO 12x4" FLOOR VENT ABS - SILVER GREY	079916212531	11.10	10
	RF41256	DEFLECTO 12x4" FLOOR VENT ABS - DUSK MUSK	079916212562	11.10	10
	RF41259	DEFLECTO 12x4" FLOOR VENT ABS - DEEP GREY	079916212593	11.10	10

## Bettavent® 300 x 100mm (12" x 4")

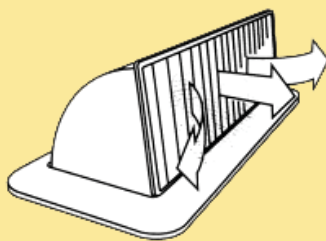

### Contents & Features...

Increase heating efficiency using the unique design of Bettavent®. Firstly, Bettavent® directs the airflow towards the middle of a room at floor level. The angled Bettavent® grill also disperses air evenly from side to side. Deflecting air before it is dispersed maintains its velocity so it projects further into a room.

- Increases heating efficiency
- Maintenance and Rust free
- 8 Attractive designer colours
- Eliminates the need of additional Air Deflectors
- Rear flange dimensions 300 x 100mm (12" x 4")
- Economical alternative to metal

#### Open position - Horizontal air flow

- Sends air out across floor-level
- Place a table over vent
- Stops rear curtains from moving

#### Half Open position - Vertical air flow

- Ideal for clothes-horse drying
- Place a table over vent

#### Closed position - No air flow

- Keeps ducting clean when not in use
- Reduced energy costs with unwanted rooms not heated



Beige



Grey



White



Green



Cream



Coffee



Chocolate



Mushroom

SKU	Model No.	Description	Barcode	List ea.	Pk. Qty.
	BV01	BETTAVENT - BEIGE	9320885691119	29.90	5
	BV02	BETTAVENT - GREY	9320885691126	29.90	5
	BV04	BETTAVENT - WHITE	9320885691249	29.90	5
	BV05	BETTAVENT - GREEN	9320885691133	29.90	5
	BV06	BETTAVENT - CREAM	9320885691164	29.90	5
	BV08	BETTAVENT - COFFEE	9320885691188	29.90	5
	BV09	BETTAVENT - CHOCOLATE	9320885691157	29.90	5
	BV10	BETTAVENT - MUSHROOM	9320885691144	29.90	5

# FLOOR VENTS

# POLYCARBONATE 300x100mm

## Polycarbonate Ducted Heating Floor Vents

300 x 100mm (12" x 4")



## Contents & Features...

The Deflect-o® range of polycarbonate plastic floor vents are available in 20 designer colours selected to blend with most modern decor schemes.

The radical design features twin air dampers to provide efficient air flow and control.

- Australian made
- Maintenance and Rust free
- Dishwasher safe
- 20 Attractive designer colours
- 5 Year replacement warranty

\*Hint - To deflect air across the floor use Model 50 or 99 Air Deflectors - Refer page 32



SKU	Model No.	Description	Barcode	List ea.	Pk. Qty.
	D201	DEFLECTO 12x4"POLY.FLOOR VENT - LIGHT BEIGE	9317468002011	19.00	10
	D202	DEFLECTO 12x4"POLY.FLOOR VENT - GREY	9317468002028	19.00	10
	D203	DEFLECTO 12x4"POLY.FLOOR VENT - PINK	9317468002035	19.00	10
	D204	DEFLECTO 12x4"POLY.FLOOR VENT - WHITE	9317468002042	19.00	10
	D205	DEFLECTO 12x4"POLY.FLOOR VENT - NEW GREEN	9317468002053	19.00	10
	D206	DEFLECTO 12x4"POLY.FLOOR VENT - CREAM	9317468002066	19.00	10
	D207	DEFLECTO 12x4"POLY.FLOOR VENT - SLATE	9317468002073	19.00	10
	D208	DEFLECTO 12x4"POLY.FLOOR VENT - COFFEE	9317468002080	19.00	10
	D209	DEFLECTO 12x4"POLY.FLOOR VENT - CHOCOLATE	9317468002097	19.00	10
	D210	DEFLECTO 12x4"POLY.FLOOR VENT - MUSHROOM	9317468002103	19.00	10
	D211	DEFLECTO 12x4"POLY.FLOOR VENT - BROWN	9317468002110	19.00	10
	D212	DEFLECTO 12x4"POLY.FLOOR VENT - TAN	9317468002127	19.00	10
	D213	DEFLECTO 12x4"POLY.FLOOR VENT - DARK BEIGE	9317468002134	19.00	10
	D214	DEFLECTO 12x4"POLY.FLOOR VENT - PEACH	9317468002141	19.00	10
	D215	DEFLECTO 12x4"POLY.FLOOR VENT - BLUE	9317468002158	19.00	10
	D216	DEFLECTO 12x4"POLY.FLOOR VENT - BALTIC PINE	9317468002165	19.00	10
	D217	DEFLECTO 12x4"POLY.FLOOR VENT - CARAMEL	9317468002172	19.00	10
	D218	DEFLECTO 12x4"POLY.FLOOR VENT - DESERT SAND	9317468002189	19.00	10
	D219	DEFLECTO 12x4"POLY.FLOOR VENT - BRUNSWICK GREEN	9317468002196	19.00	10
	D220	DEFLECTO 12x4"POLY.FLOOR VENT - STEEL BLUE	9317468002202	19.00	10



# FLOOR VENTS

# POLYCARBONATE 350x150mm

## Polycarbonate Ducted Heating Floor Vents 350 x 150mm (14" x 6")



### Contents & Features...

The Deflect-o® range of polycarbonate plastic floor vents are available in 20 designer colours selected to blend with most modern decor schemes.

The radical design features triple air dampers to provide efficient air flow and control.

- Australian made
- Maintenance and Rust free
- Dishwasher safe
- 20 Attractive designer colours
- 5 Year replacement warranty

\*Hint - To deflect air across the floor use Model 50 or 99 Air Deflectors - Refer page 32

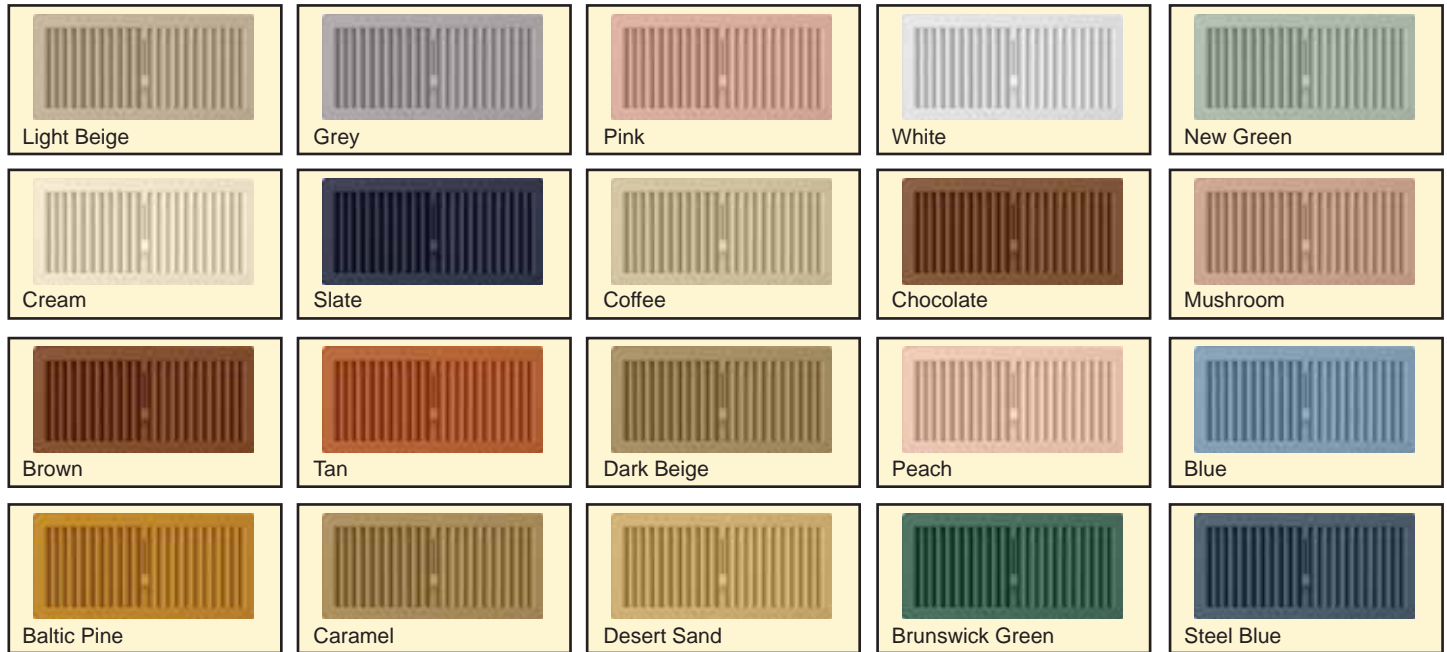

SKU	Model No.	Description	Barcode	List ea.	Pk. Qty.
	D221	DEFLECTO 14x6"POLY.FLOOR VENT - LIGHT BEIGE	9317468002219	51.00	10
	D222	DEFLECTO 14x6"POLY.FLOOR VENT - GREY	9317468002226	51.00	10
	D223	DEFLECTO 14x6"POLY.FLOOR VENT - PINK	9317468002233	51.00	10
	D224	DEFLECTO 14x6"POLY.FLOOR VENT - WHITE	9317468002240	51.00	10
	D225	DEFLECTO 14x6"POLY.FLOOR VENT - NEW GREEN	9317468002257	51.00	10
	D226	DEFLECTO 14x6"POLY.FLOOR VENT - CREAM	9317468002264	51.00	10
	D227	DEFLECTO 14x6"POLY.FLOOR VENT - SLATE	9317468002271	51.00	10
	D228	DEFLECTO 14x6"POLY.FLOOR VENT - COFFEE	9317468002288	51.00	10
	D229	DEFLECTO 14x6"POLY.FLOOR VENT - CHOCOLATE	9317468002295	51.00	10
	D230	DEFLECTO 14x6"POLY.FLOOR VENT - MUSHROOM	9317468002301	51.00	10
	D231	DEFLECTO 14x6"POLY.FLOOR VENT - BROWN	9317468002318	51.00	10
	D232	DEFLECTO 14x6"POLY.FLOOR VENT - TAN	9317468002325	51.00	10
	D233	DEFLECTO 14x6"POLY.FLOOR VENT - DARK BEIGE	9317468002332	51.00	10
	D234	DEFLECTO 14x6"POLY.FLOOR VENT - PEACH	9317468002349	51.00	10
	D235	DEFLECTO 14x6"POLY.FLOOR VENT - BLUE	9317468002356	51.00	10
	D236	DEFLECTO 14x6"POLY.FLOOR VENT - BALTIC PINE	9317468002363	51.00	10
	D237	DEFLECTO 14x6"POLY.FLOOR VENT - CARAMEL	9317468102377	51.00	10
	D238	DEFLECTO 14x6"POLY.FLOOR VENT - DESERT SAND	9317468102384	51.00	10
	D239	DEFLECTO 14x6"POLY.FLOOR VENT - BRUNSWICK GREEN	9317468102391	51.00	10
	D240	DEFLECTO 14x6"POLY.FLOOR VENT - STEEL BLUE	9317468102407	51.00	10

# FLOOR VENTS

# METAL 300x100mm

## Metal Vents 300 x 100mm (12" x 4")

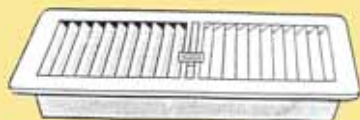

### Contents & Features...

- Standard design with angled grills
  - Metal vent and damper construction
  - Powder coated finish
  - Colour coded dampers
  - Centre damper control button
- 
- Ideal for high traffic areas
  - Ideal for areas within chair or table legs vicinities

\*Hint - To deflect air across the floor use Model 50 or 99 Air Deflectors - Refer page 32



SKU	Model No.	Description	Barcode	List ea.	Pk. Qty.
	DMR1203	DEFLECTO METAL REG.FLOOR 12x4" - WHITE	9317468002370	40.00	9
	DMR1213	DEFLECTO METAL REG.FLOOR 12x4" - IRON BROWN	9317468002387	40.00	9
	DMR1217	DEFLECTO METAL REG.FLOOR 12x4" - SMOOTH CREAM	9317468002394	40.00	9
	DMR1218	DEFLECTO METAL REG.FLOOR 12x4" - STONE	9317468002400	40.00	9
	DMR1226	DEFLECTO METAL REG.FLOOR 12x4" - EARTH	9317468002417	40.00	9
	DMR1228	DEFLECTO METAL REG.FLOOR 12x4" - BEIGE	9317468002424	40.00	9
	DMR1239	DEFLECTO METAL REG.FLOOR 12x4" - HONEYWOOD	9317468002431	40.00	9
	DMR1244	DEFLECTO METAL REG.FLOOR 12x4" - GUM GREEN	9317468002448	40.00	9
	DMR1249	DEFLECTO METAL REG.FLOOR 12x4" - CHERRYWOOD	9317468002455	40.00	9
	DMR1253	DEFLECTO METAL REG.FLOOR 12x4" - SILVER GREY	9317468002462	40.00	9
	DMR1256	DEFLECTO METAL REG.FLOOR 12x4" - DUSK MUSK	9317468002479	40.00	9
	DMR1259	DEFLECTO METAL REG.FLOOR 12x4" - DEEP GREY	9317468002486	40.00	9

# FLOOR VENTS

# METAL - OVERSIZED

## Metal Vents Oversized



### Contents & Features...

- Standard design with angled grills
- Metal vent and damper construction
- Powder coated finish
- Centre damper control button
- Ideal for high traffic areas
- Ideal for areas within chair or table legs vicinities

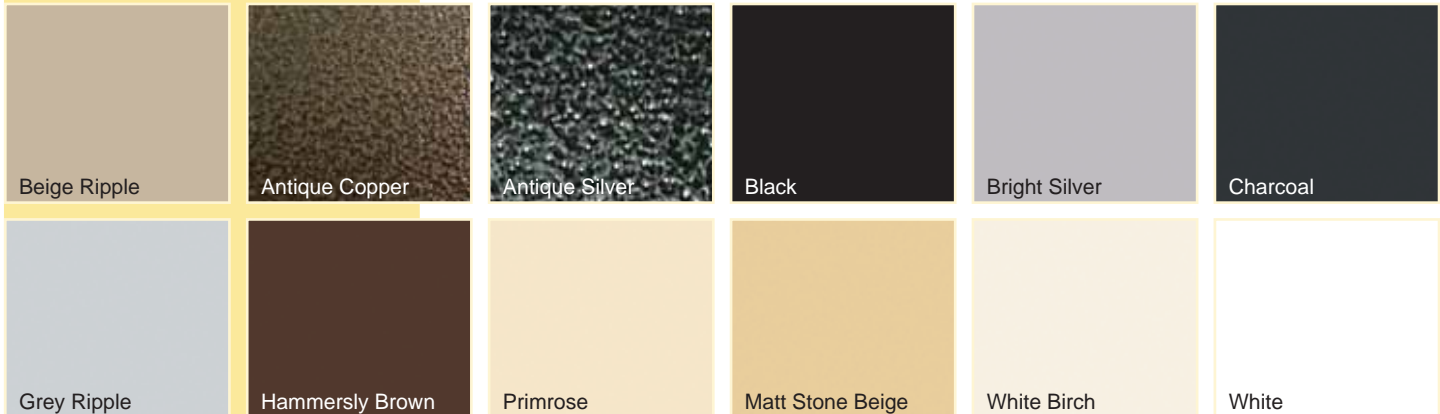

## Metal Vents 400 x 100mm (16" x 4")



SKU	Model No.	Description	Barcode	List ea.	Pk. Qty.
	REG164	REG.16x4"METAL VENT - BEIGE RIPPLE	9317468001649	78.00	6
	REG164AC	REG.16x4"METAL VENT - ANTIQUE COPPER	9317468001656	78.00	6
	REG164AS	REG.16x4"METAL VENT - ANTIQUE SILVER	9317468001670	78.00	6
	REG164BL	REG.16x4"METAL VENT - BLACK	9317468001687	78.00	6
	REG164BS	REG.16x4"METAL VENT - BRIGHT SILVER	9317468001694	78.00	6
	REG164CH	REG.16x4"METAL VENT - CHARCOAL	9317468001700	78.00	6
	REG164GR	REG.16x4"METAL VENT - GREY RIPPLE	9317468001724	78.00	6
	REG164HB	REG.16x4"METAL VENT - HAMMERSELY BROWN	9317468001731	78.00	6
	REG164PR	REG.16x4"METAL VENT - PRIMROSE	9317468001748	78.00	6
	REG164SB	REG.16x4"METAL VENT - MATT STONE BEIGE	9317468001762	78.00	6
	REG164WB	REG.16x4"METAL VENT - WHITE BIRCH	9317468001779	78.00	6
	REG164WH	REG.16x4"METAL VENT- WHITE	9317468001786	78.00	6

## Metal Vents 350 x 150mm (14" x 6")



SKU	Model No.	Description	Barcode	List ea.	Pk. Qty.
	REG146	REG.14x6"METAL VENT - BEIGE	9317468001465	99.00	6
	REG146AC	REG.14x6"METAL VENT - ANTIQUE COPPER	9317468001472	99.00	6
	REG146AS	REG.14x6"METAL VENT - ANTIQUE SILVER	9317468001496	99.00	6
	REG146BL	REG.14x6"METAL VENT - BLACK	9317468001502	99.00	6
	REG146BS	REG.14x6"METAL VENT - BRIGHT SILVER	9317468001519	99.00	6
	REG146CH	REG.14x6"METAL VENT - CHARCOAL	9317468001526	99.00	6
	REG146GR	REG.16x4"METAL VENT - GREY RIPPLE	9317468001540	99.00	6
	REG146HB	REG.14x6"METAL VENT - HAMMERSLEY BROWN	9317468001557	99.00	6
	REG146PR	REG.14x6"METAL VENT - PRIMROSE	9317468001564	99.00	6
	REG146SB	REG.14x6"METAL VENT - STONE BEIGE	9317468001588	99.00	6
	REG146WB	REG.14x6"METAL VENT- WHITE BIRCH	9317468001595	99.00	6
	REG146WH	REG.14x6"METAL VENT - WHITE	9317468001601	99.00	6

# FLOOR VENTS

# AIR DEFLECTORS

## 40 Ducted Cooling Air Deflector



### Contents & Features...

Air flow is concentrated upwards to break up the stratified air and provide a more even temperature between the ceiling and floor.

- Adjustable 250mm - 360mm x 100mm Deep
- Designed to break up stratified air
- Supplied with strong metal magnets



SKU	Model No.	Description	Barcode	List ea.	Pk. Qty.
	40	DEFLECTO AIR-CONDITIONING AIR DEFLECTOR	079916000404	16.40	12

## 50 Premium Unbreakable Air Deflector



### Contents & Features...

Increase heating efficiency and save money by directing air flow from floor vents along the floor rather than up walls or behind curtains and furniture.

- Adjustable 250mm - 360mm x 100mm Deep
- Clear polycarbonate plastic
- Unbreakable under normal use
- Supplied with strong metal magnets & Velcro®



SKU	Model No.	Description	Barcode	List ea.	Pk. Qty.
	50	DEFLECTO PREMIUM AIR DEFLECTOR UNBREAK.	079916000503	18.00	12

## 51 Large Floor and/or Wall Air Deflector

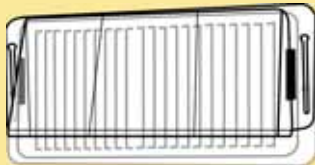

### Contents & Features...

Increase heating efficiency and save money by directing air flow from floor vents along the floor rather than up walls or behind curtains and furniture.

- Suited to 350 x 150mm (14" x 6") Floorvents
- Adjustable 250mm - 360mm x 150mm Deep
- Supplied with strong metal magnets



SKU	Model No.	Description	Barcode	List ea.	Pk. Qty.
	51	DEFLECTO LARGE AIR DEFLECTOR SUIT 14"x 6"	079916000510	22.00	12

## 67 Extension Sleeve For Model 99 Air Deflector

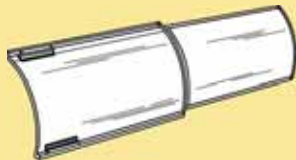

### Contents & Features...

Use this extension sleeve to extend the length of Model 99 and Model 50 Air Deflectors by up to 250mm in length.

- Clear acrylic
- Inserts between sides of Air Deflector
- Suits 400 x 100mm (16" x 4") Floorvents
- Adds up to 250mm length to Model 99 & 50 Air Deflectors



SKU	Model No.	Description	Barcode	List ea.	Pk. Qty.
	67	DEFLECTO EXTENSION SLEEVE FOR MODEL 99	079916000676	8.50	12

## 99 Standard Air Deflector



### Contents & Features...

Increase heating efficiency and save money by directing air flow from floor vents along the floor rather than up walls or behind curtains and furniture.

- Adjustable 250mm - 360mm x 100mm Deep
- Supplied with strong metal magnets & Velcro®
- Standard quality - for Unbreakable see Model 50 above



SKU	Model No.	Description	Barcode	List ea.	Pk. Qty.
	99	DEFLECTO DUCTED HEAT AIR DEFLECTOR STD.	079916000992	11.90	12



# FLOOR VENTS

# ACCESSORIES

## Plastic Floor Vent Boot



## Contents & Features...

Made from black, blown moulded plastic with internal pivot damper for adjustable air volume control.  
Suits metal and plastic Floorvents with below listed dimensions.



- Subfloor or wall mountable

### D301 300 x 100mm

- Suits 150mm Ducting

- For vents refer pages 26-28 & 30

SKU	Model No.	Description	Barcode	List ea.	Pk. Qty.
	D301	DEFLECTO 12"x4" FLOOR BOOT TO FIT 6" DUCT	9317468603010	13.00	6

### D302 300 x 100mm

- Suits 200mm Ducting

- For vents refer pages 26-28 & 30

SKU	Model No.	Description	Barcode	List ea.	Pk. Qty.
	D302	DEFLECTO 12"x4" FLOOR BOOT TO FIT 8" DUCT	9317468603027	25.80	6

### D303 350 x 150mm

- Suits 200mm Ducting

- For vents refer pages 29 & 31

SKU	Model No.	Description	Barcode	List ea.	Pk. Qty.
	D303	DEFLECTO 14"x6" FLOOR BOOT TO FIT 8" DUCT	9317468603034	50.00	6

### D304 350 x 150mm

- Suits 250mm Ducting

- For vents refer pages 29 & 31

SKU	Model No.	Description	Barcode	List ea.	Pk. Qty.
	D304	DEFLECTO 14"x6" FLOOR BOOT TO FIT 10" DUCT	9317468603034	75.00	6

## 'Y' Branch Take-Off



## Contents & Features...

Made from black, blown moulded plastic these "Y" branches allow for a venting system to be directed to / received from two evenly distributed areas.



- 50/50 Split of airflow

### DY866 8" x 6" x 6"

- Plastic 'Y' branch

- Connects 200 x 150 x 150mm (8" x 6" x 6")

SKU	Model No.	Description	Barcode	List ea.	Pk. Qty.
	DY866	PLASTIC "Y" DUCT CONNECTOR 8"-6"-6"	9317468681155	25.00	6

### DY1088 10" x 8" x 8"

- Plastic 'Y' branch

- Connects 250 x 200 x 200mm (10" x 8" x 8")

SKU	Model No.	Description	Barcode	List ea.	Pk. Qty.
	DY1088	PLASTIC "Y" DUCT CONNECTOR 10"-8"-8"	??	55.00	6

## Single Branch Take-Off



## Contents & Features...

Made from black, blown moulded plastic these Branch Take-Offs allow for a venting system to be directed to / received from two areas. The 45 degree angle Take-Off will offer a lesser or a more subtle volume of air to a secondary room as majority of airflow will be sent to the in-line outlet.



### D866 8" x 6" x 6"

- 45 Degree x 150mm Branch Take-Off

- Connects 200 x 150 x 150mm (8" x 6" x 6")

SKU	Model No.	Description	Barcode	List ea.	Pk. Qty.
	D866	PLASTIC BRANCH TAKE-OFF 8x6x6	9317468608664	25.00	6

### D886 8" x 8" x 6"

- 45 Degree x 150mm Branch Take-Off

- Connects 200 x 200 x 150mm (8" x 8" x 6")

SKU	Model No.	Description	Barcode	List ea.	Pk. Qty.
	D886	PLASTIC BRANCH TAKE OFF 8x8x6	9317468608862	33.30	6

### D1088 10" x 8" x 8"

- 45 Degree x 200mm Branch Take-Off

- Connects 250 x 200 x 200mm (10" x 8" x 8")

SKU	Model No.	Description	Barcode	List ea.	Pk. Qty.
	D1088	PLASTIC BRANCH TAKE OFF 10x8x8	9317468610889	37.00	6

# FLOOR VENTS

# ACCESSORIES

## Single Branch Take-Off



### Contents & Features...

- For subtle airflow to additional rooms
- Black, blown mould plastic

**D10108**      **10" x 10" x 8"**      • 45 degree x 200mm Branch Take-Off      • Connects 250 x 250 x 200mm (10" x 10" x 8")

SKU	Model No.	Description	Barcode	List ea.	Pk. Qty.
	D10108	PLASTIC BRANCH TAKE-OFF 10x10x8	9317468101073	39.00	6

**D121010**      **12" x 10" x 10"**      • 45 degree x 250mm Branch Take-Off      • Connects 300 x 250 x 250mm (12" x 10" x 10")

SKU	Model No.	Description	Barcode	List ea.	Pk. Qty.
	D121010	PLASTIC BRANCH TAKE OFF 12x10x10	9317468121019	55.00	6

**D121210**      **12" x 12" x 10"**      • 45 degree x 250mm Branch Take-Off      • Connects 300 x 300 x 250mm (12" x 12" x 10")

SKU	Model No.	Description	Barcode	List ea.	Pk. Qty.
	D121210	PLASTIC BRANCH TAKE OFF 12x12x10	9317468121217	55.00	6

## Insulated Duct 3 Metre Length



### Contents & Features...

- Fully Insulated - Fire rated ducting
- Complies to Australian Standards

**D603M**      **150mm x 3M**      • 150mm x 3 Metre length

SKU	Model No.	Description	Barcode	List ea.	Pk. Qty.
	D603M	FIRE RATED INSULATED DUCT 6"x 3M	9317468606035	36.50	6

**D803M**      **200mm x 3M**      • 200mm x 3 Metre length

SKU	Model No.	Description	Barcode	List ea.	Pk. Qty.
	D803M	FIRE RATED INSULATED DUCT 8"x 3M	9317468608039	47.00	6

**D1003M**      **250mm x 3M**      • 250mm x 3 Metre length

SKU	Model No.	Description	Barcode	List ea.	Pk. Qty.
	D1003M	FIRE RATED INSULATED DUCT 10"x 3M	9317468610032	65.00	6

**D1203M**      **300mm x 3M**      • 300mm x 3 Metre length

SKU	Model No.	Description	Barcode	List ea.	Pk. Qty.
	D1203M	FIRE RATED INSULATED DUCT 12"x 3M	9317468612036	70.00	6

## Insulated Duct 6 Metre Length



### Contents & Features...

- Fully Insulated - Fire rated ducting
- Complies to Australian Standards

**D606M**      **150mm x 6M**      • 150mm x 6 Metre length

SKU	Model No.	Description	Barcode	List ea.	Pk. Qty.
	D606M	FIRE RATED INSULATED DUCT 6"x 6M	9317468606066	70.00	6

**D806M**      **200mm x 6M**      • 200mm x 6 Metre length

SKU	Model No.	Description	Barcode	List ea.	Pk. Qty.
	D806M	FIRE RATED INSULATED DUCT 8"x 6M	9317468608060	90.00	6

**D1006M**      **250mm x 6M**      • 250mm x 6 Metre length

SKU	Model No.	Description	Barcode	List ea.	Pk. Qty.
	D1006M	FIRE RATED INSULATED DUCT 10"x 6M	9317468610063	116.00	6

**D1206M**      **300mm x 6M**      • 300mm x 6 Metre length

SKU	Model No.	Description	Barcode	List ea.	Pk. Qty.
	D1206M	FIRE RATED INSULATED DUCT 12"x 6M	9317468612067	140.00	6

## Gravity Louvred



### Contents & Features...

The gravity louvred vent - commonly known as a flap vent - is designed to allow air to be vented to atmosphere, while stopping cold air and pests entering the system when not in use. The louvres are specially manufactured in a curved shape to assist in keeping the vent closed if effected by wind or drafts. Modern, rounded edges with mounting holes in each corner.

- Retail packed
- UV Resistant
- Calcium filled polypropylene plastic
- 25mm Rear flange for ducting attachment

\*Hint - use with metal worm drive clamp to secure ducting



### HSR4W 100mm White

- Suits 100mm (4") diameter duct
- 150 x 150mm (6" x 6") External dimensions

SKU	Model No.	Description	Barcode	List ea.	Pk. Qty.
	HSR4W	DEFLECTO WALL VENT GRAVITY 100MM WHITE	079916500539	14.70	6

### HSR5W 125mm White

- Suits 125mm (5") diameter duct
- 205 x 205mm (8" x 8") External dimensions

SKU	Model No.	Description	Barcode	List ea.	Pk. Qty.
	HSR5W	DEFLECTO WALL VENT GRAVITY 125MM WHITE	079916502106	26.00	6

### HSR6W 150mm White

- Suits 150mm (6") diameter duct
- 205 x 205mm (8" x 8") External dimensions

SKU	Model No.	Description	Barcode	List ea.	Pk. Qty.
	HSR6W	DEFLECTO WALL VENT GRAVITY 150MM WHITE	079916500553	26.00	6

### HS7W 175mm White

- Suits 175mm (7") diameter duct
- 230 x 230mm (9" x 9") External dimensions

SKU	Model No.	Description	Barcode	List ea.	Pk. Qty.
	HS7W	DEFLECTO WALL VENT GRAVITY 180MM WHITE BULK	079916502170	33.00	6

### MV200 200mm White

- Suits 200mm (8") diameter duct
- 250 x 250mm (10" x 10") External dimensions

SKU	Model No.	Description	Barcode	List ea.	Pk. Qty.
	MV200	ATC WALL VENT GRAVITY 200MM WHITE	9317468147064	33.90	12

## Gravity Louvred



### Contents & Features...

The gravity louvred vent - commonly known as a flap vent - is designed to allow air to be vented to atmosphere, while stopping cold air and pests entering the system when not in use. The louvres are specially manufactured in a curved shape to assist in keeping the vent closed if effected by wind or drafts. Modern, rounded edges with mounting holes in each corner.

- Retail packed
- UV Resistant
- Calcium filled polypropylene plastic
- 25mm Rear flange for ducting attachment

\*Hint - use with metal worm drive clamp to secure ducting



### HSR4B 100mm Brown

- Suits 100mm (4") diameter duct
- 150 x 150mm (6" x 6") External dimensions

SKU	Model No.	Description	Barcode	List ea.	Pk. Qty.
	HSR4B	DEFLECTO WALL VENT GRAVITY 100MM BROWN	079916500546	14.90	6

### HSR5B 125mm Brown

- Suits 125mm (5") diameter duct
- 205 x 205mm (8" x 8") External dimensions

SKU	Model No.	Description	Barcode	List ea.	Pk. Qty.
	HSR5B	DEFLECTO WALL VENT GRAVITY 125MM BROWN	9317468502115	26.00	6

### HSR6B 150mm Brown

- Suits 150mm (6") diameter duct
- 205 x 205mm (8" x 8") External dimensions

SKU	Model No.	Description	Barcode	List ea.	Pk. Qty.
	HSR6B	DEFLECTO WALL VENT GRAVITY 150MM BROWN	079916500589	26.00	6

# VENTS - RETAIL

# WALL - STAINLESS STEEL

## Gravity Louvred



## Contents & Features...

Manufactured in quality stainless steel, this gravity louvred vent - commonly known as a flap vent - is designed to allow air to be vented to atmosphere, while stopping cold air and pests entering the system when not in use.

Supplied with a cinder mesh - rear flange attachment, screws and rubber gasket.

- Retail packed
- Rust proof - 18/10 Stainless steel
- Rear flange for ducting attachment

\*Hint - use with metal worm drive clamp to secure ducting



## GVSS100 100mm Stainless Steel

- Suits 100mm (4") diameter duct
- D50mm Rear flange
- H155 x W155 x D17mm External dimensions

SKU	Model No.	Description	Barcode	List ea.	Pk. Qty.
	GVSS100	GRAVITY VENT S/STEEL WALL 100MM	9317468004503	40.00	6

## GVSS125 125mm Stainless Steel

- Suits 125mm (5") diameter duct
- D50mm Rear flange
- H180 x W180 x D23mm External dimensions

SKU	Model No.	Description	Barcode	List ea.	Pk. Qty.
	GVSS125	GRAVITY VENT S/STEEL WALL 125MM	9317468004510	48.00	6

## GVSS150 150mm Stainless Steel

- Suits 150mm (6") diameter duct
- D60mm Rear flange
- H180 x W180 x D23mm External dimensions

SKU	Model No.	Description	Barcode	List ea.	Pk. Qty.
	GVSS150	GRAVITY VENT S/STEEL WALL 150MM	9317468004527	58.00	6

## GVSS200 200mm Stainless Steel

- Suits 200mm (8") diameter duct
- Under development - available late 2007

SKU	Model No.	Description	Barcode	List ea.	Pk. Qty.
	GVSS200	GRAVITY VENT S/STEEL WALL 200MM	9317468004534	P.O.A.	6

## Hood Vent

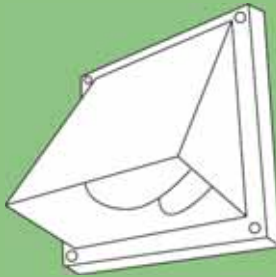

## Contents & Features...

Manufactured in quality stainless steel, this hood vent is ideal for snow and heavy rain regions. The internal gravity flap allows air to be vented to atmosphere, while stopping cold air and pests entering the system when not in use.

Supplied with a cinder mesh - rear flange attachment, screws and rubber gasket.

- Retail packed
- Rust proof - 18/10 Stainless steel
- Rear flange for ducting attachment



## HVSS100 100mm Stainless Steel

- Suits 100mm (4") diameter duct
- D50mm Rear flange
- H155 x W155 x D80mm External dimensions

SKU	Model No.	Description	Barcode	List ea.	Pk. Qty.
	HVSS100	HOOD VENT S/STEEL WALL 100MM	9317468004541	44.00	6

## HVSS125 125mm Stainless Steel

- Suits 125mm (5") diameter duct
- D50mm Rear flange
- H180 x W180 x D90mm External dimensions

SKU	Model No.	Description	Barcode	List ea.	Pk. Qty.
	HVSS125	HOOD VENT S/STEEL WALL 125MM	9317468004558	52.00	6

## HVSS150 150mm Stainless Steel

- Suits 150mm (6") diameter duct
- D60mm Rear flange
- H180 x W180 x D90mm External dimensions

SKU	Model No.	Description	Barcode	List ea.	Pk. Qty.
	HVSS150	HOOD VENT S/STEEL WALL 150MM	9317468004565	60.00	6



# VENTS - RETAIL

# WALL/EAVE - STAINLESS STEEL

## Round Flush - Mesh Vent

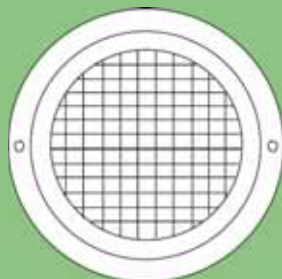

### Contents & Features...

Manufactured in quality stainless steel, this round, flush vent is ideal for under-eave venting. The open mesh face allows it to be also used for wall or ceilings, as an inlet or outlet vent. Supplied with a cinder mesh - rear flange attachment, screws and rubber gasket.

- Retail packed
- Rust proof - 18/10 Stainless steel
- Rear flange for ducting attachment

\*Hint - use with metal worm drive clamp to secure ducting



### EVSS100 100mm Stainless Steel

- Suits 100mm (4") diameter duct
- D50mm Rear flange
- 150mm Outer diameter

SKU	Model No.	Description	Barcode	List ea.	Pk. Qty.
	EVSS100	EAVE VENT S/STEEL 100MM	9317468004572	36.00	6

### EVSS125 125mm Stainless Steel

- Suits 125mm (5") diameter duct
- D50mm Rear flange
- 185mm Outer diameter

SKU	Model No.	Description	Barcode	List ea.	Pk. Qty.
	EVSS125	EAVE VENT S/STEEL 125MM	9317468004589	40.00	6

### EVSS150 150mm Stainless Steel

- Suits 150mm (6") diameter duct
- D60mm Rear flange
- 210mm Outer diameter

SKU	Model No.	Description	Barcode	List ea.	Pk. Qty.
	EVSS150	EAVE VENT S/STEEL 150MM	9317468004596	48.00	6

### EVSS200 200mm Stainless Steel

- Suits 200mm (8") diameter duct
- D70mm Rear flange
- 265mm Outer diameter

SKU	Model No.	Description	Barcode	List ea.	Pk. Qty.
	EVSS200	EAVE VENT S/STEEL 200MM	9317468004602	65.00	6

## Dome Vent - Fixed Louvred



### Contents & Features...

Manufactured in quality stainless steel, this dome styled vent is an alternative fixed louvred, Wall vent that is protected by a stylish round hood. May also be used as an inlet vent. Supplied with a cinder mesh - rear flange attachment, screws and rubber gasket.

- Retail packed
- Rust proof - Stainless Steel
- Rear flange for ducting attachment

\*Hint - use with metal worm drive clamp to secure ducting



### DVSS100 100mm Stainless Steel

- Suits 100mm (4") diameter duct
- D50mm Rear flange
- 150mm Outer diameter x D85mm

SKU	Model No.	Description	Barcode	List ea.	Pk. Qty.
	DVSS100	DOME VENT S/STEEL 100MM	9317468004619	40.00	6

### DVSS125 125mm Stainless Steel

- Suits 125mm (5") diameter duct
- D50mm Rear flange
- 185mm Outer diameter X D95mm

SKU	Model No.	Description	Barcode	List ea.	Pk. Qty.
	DVSS125	DOME VENT S/STEEL 125MM	9317468004626	48.00	6

### DVSS150 150mm Stainless Steel

- Suits 150mm (6") diameter duct
- D50mm Rear flange
- 210mm Outer diameter x D105mm

SKU	Model No.	Description	Barcode	List ea.	Pk. Qty.
	DVSS150	DOME VENT S/STEEL 150MM	9317468004633	58.00	6

# VENTS - RETAIL

# WALL/EAVE - PLASTIC

## Fixed Louvred



## Contents & Features...

The fixed louvred vents in this range may be used as an outlet, or fresh air intake vent. The 100mm vent has vertical grills between the louvres, whilst the 125 & 150mm vents have a 12mm mesh on their rear flanges, to prevent birds and rodents from entering.

- UV Resistant
- White - Calcium filled polypropylene plastic



### HSM4WR 100mm White

- Suits 100mm (4") diameter duct
- H150 x W150mm (6" x 6") External dimensions

SKU	Model No.	Description	Barcode	List ea.	Pk. Qty.
	HSM4WR	DEFLECTO FIXED LOUVRE VENT 100MM WHITE	9317468671941	14.90	6

### HSM5WR 125mm White

- Suits 125mm (5") diameter duct
- H205 x W205mm (8" x 8") External dimensions

SKU	Model No.	Description	Barcode	List ea.	Pk. Qty.
	HSM5WR	DEFLECTO FIXED LOUVRE VENT 125MM WHITE	9317468671958	26.00	6

### HSM6WR 150mm White

- Suits 150mm (6") diameter duct
- H205 x W205mm (8" x 8") External dimensions

SKU	Model No.	Description	Barcode	List ea.	Pk. Qty.
	HSM6WR	DEFLECTO FIXED LOUVRE VENT 150MM WHITE	9317468671965	26.00	6

## Fixed Louvred

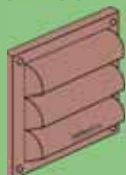

## Contents & Features...

The fixed louvred vents in this range may be used as an outlet, or fresh air intake vent. The 100mm vent has vertical grills between the louvres, whilst the 125 & 150mm vents have a 12mm mesh on their rear flanges, to prevent birds and rodents from entering.

- UV Resistant
- White - Calcium filled polypropylene plastic



### HSM4BR 100mm Brown

- Suits 100mm (4") diameter duct
- H150 x W150mm (6" x 6") External dimensions

SKU	Model No.	Description	Barcode	List ea.	Pk. Qty.
	HSM4BR	DEFLECTO FIXED LOUVRE VENT 100MM BROWN	9317468010047	14.90	6

### HSM5BR 125mm Brown

- Suits 125mm (5") diameter duct
- H205 x W205mm (8" x 8") External dimensions

SKU	Model No.	Description	Barcode	List ea.	Pk. Qty.
	HSM5BR	DEFLECTO FIXED LOUVRE VENT 125MM BROWN	9317468010054	26.00	6

### HSM6BR 150mm Brown

- Suits 150mm (6") diameter duct
- H205 x W205mm (8" x 8") External dimensions

SKU	Model No.	Description	Barcode	List ea.	Pk. Qty.
	HSM6BR	DEFLECTO FIXED LOUVRE VENT 150MM BROWN	9317468010061	26.00	6

## Fixed Louvred - Square



## Contents & Features...

Economy standard fixed louvred vent that may be used for wall or eave venting. Not recommended for rangehood use as they are supplied with flyscreen mesh that can clog and restrict airflow. Ideally used as an internal, intake vent.

- Removable front grill

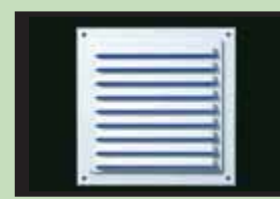

### MV100VS 100mm White

- Suits 100mm (4") diameter duct
- H152 x W152mm External dimensions

SKU	Model No.	Description	Barcode	List ea.	Pk. Qty.
	MV100VS	ATC SQ. WALL VENT W/SCREEN 100MM	9317468147132	10.30	12

### MV120VS 125mm White

- Suits 125mm (5") diameter duct
- H185 x W185mm External dimensions

SKU	Model No.	Description	Barcode	List ea.	Pk. Qty.
	MV120VS	ATC SQ. WALL VENT W/SCREEN 125MM	9317468147149	13.50	12

### MV150VS 150mm White

- Suits 150mm (6") diameter duct
- H185 x W185mm External dimensions

SKU	Model No.	Description	Barcode	List ea.	Pk. Qty.
	MV150VS	ATC SQ. WALL VENT W/SCREEN 150MM	9317468147156	16.50	12

## Fixed Louvred - Round



### Contents & Features...

Economy standard fixed louvred vent that may be used for wall or eave venting. Not recommended for rangehood use as they are supplied with flyscreen mesh that can clog and restrict airflow. Ideally used as an internal, intake vent.



### MV100BVS 100mm White

- Suits 100mm (4") diameter duct
- 128mm Diameter external dimensions

SKU	Model No.	Description	Barcode	List ea.	Pk. Qty.
	MV100BVS	ATC ROUND VENT W/SCREEN 100MM	9317468147101	7.70	12

### MV125BVS 125mm White

- Suits 125mm (5") diameter duct
- 160mm Diameter external dimensions

SKU	Model No.	Description	Barcode	List ea.	Pk. Qty.
	MV125BVS	ATC ROUND VENT W/SCREEN 125MM	9317468147118	10.30	12

### MV150BVS 150mm White

- Suits 150mm (6") diameter duct
- 200mm Diameter external dimensions

SKU	Model No.	Description	Barcode	List ea.	Pk. Qty.
	MV150BVS	ATC ROUND VENT W/SCREEN 150MM	9317468147125	12.90	12

## EVE Under Eave Vent

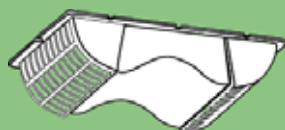

### Contents & Features...

Clever by design, this vent offers under-eave venting for diameters up to 150mm. It uniquely allows air to exhaust efficiently past 2 backflow control dampers that shut when not in use.

- L260mm x W180mm x D60mm
- Ensure the hole cut in the eave is set between the 2 dampers
- \*Hint - For 150mm, cut a rectangular hole & square-up ducting



SKU	Model No.	Description	Barcode	List ea.	Pk. Qty.
	EVE	DEFLECT-O UNDER-EAVE VENT 75 -150MM	079916500805	28.00	6

## RCT Low Profile Roof Cap Exhaust



### Contents & Features...

Self-flashing on slate and flat bitumen style roofs. This low profile vent has an internal damper that closes when not in use. Offers 100mm and 125mm connection tail piece.

- Black polypropylene plastic
- Prevents rain, bird and vermin entry
- Roof specific flashing may be required



SKU	Model No.	Description	Barcode	List ea.	Pk. Qty.
	RCT	DEFLECTO ROOF CAP VENT L/PROFILE 100/125MM	079916202105	69.00	6

## Roof Mushroom Cowl



### Contents & Features...

The unique design of this cowl offers superior protection from rain, back drafts and rodents - unlike regular open type roof cowls. Matches with GSPS and PPX coded piping. Refer page 49

- Pleasing aesthetics
- Minimises rain, bird and vermin entry
- Provides efficient air/ exhaust expulsion



### RMC4 100mm - Galvanised

- Suits 100mm (4") Venting systems
- Galvanised steel construction

SKU	Model No.	Description	Barcode	List ea.	Pk. Qty.
	RMC4	DEFLECTO ROOF MUSHROOM COWL GALV 100MM	9317468612074	31.90	6

### RMC5 125mm - Aluminium

- Suits 125mm (5") Venting systems
- Aluminium construction

SKU	Model No.	Description	Barcode	List ea.	Pk. Qty.
	RMC5	DEFLECTO ROOF MUSHROOM COWL ALUM 125MM	9317468612081	34.90	6

### RMC6 150mm - Aluminium

- Suits 150mm (6") Venting systems
- Aluminium construction

SKU	Model No.	Description	Barcode	List ea.	Pk. Qty.
	RMC6	DEFLECTO ROOF MUSHROOM COWL ALUM 150MM	9317468612098	37.90	6



# VENTS - RETAIL

# INLET - CEILING

## Euro Style Diffuser



### Contents & Features...

Commonly used for air intake, the design of these ceiling diffusers accepts air from surrounding surfaces and not directly below. This makes it ideal for heat, smoke and vapour extraction/ transfer. For desired airflow control, simply screw the inverted cone centre.

- White - Plastic
- Adjustable closure
- Easy installation and removal for cleaning



### TFG4 100mm White

- Suits 100mm diameter duct
- 150mm Outer diameter

SKU	Model No.	Description	Barcode	List ea.	Pk. Qty.
	TFG4	DEFLECTO CEILING DIFFUSER/INTAKE 100MM	079916934310	17.00	6

### TFG6 150mm White

- Suits 150mm diameter duct
- 200mm Outer diameter

SKU	Model No.	Description	Barcode	List ea.	Pk. Qty.
	TFG6	DEFLECTO CEILING DIFFUSER/INTAKE 150MM	079916934216	24.00	6

## Ceiling Diffuser



### Contents & Features...

Commonly used for air intake, the design of these ceiling diffusers accepts air from surrounding surfaces and not directly below. This makes it ideal for heat, smoke and vapour extraction/ transfer. For desired airflow control, simply screw the inverted cone centre.

- Australian made
- White - Plastic
- Adjustable closure



### CD150 150mm White

- Suits 150mm diameter duct
- 270mm Outer diameter

SKU	Model No.	Description	Barcode	List ea.	Pk. Qty.
	CD150	DEFLECTO CEILING DIFFUSER/INTAKE 150MM	9317468671729	39.50	6

### CD200 200mm White

- Suits 200mm diameter duct
- 320mm Outer diameter

SKU	Model No.	Description	Barcode	List ea.	Pk. Qty.
	CD200	DEFLECTO CEILING DIFFUSER/INTAKE 200MM	9317468671736	48.50	6

### CD250 250mm White

- Suits 250mm diameter duct
- 395mm Outer diameter

SKU	Model No.	Description	Barcode	List ea.	Pk. Qty.
	CD250	DEFLECTO CEILING DIFFUSER/INTAKE 250MM	9317468671743	55.00	6

### CD300 300mm White

- Suits 300mm diameter duct
- 440mm Outer diameter

SKU	Model No.	Description	Barcode	List ea.	Pk. Qty.
	CD300	DEFLECTO CEILING DIFFUSER/INTAKE 300MM	9317468671750	80.00	6

## Square Egg Crate Grill

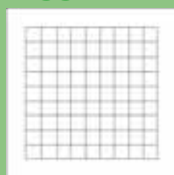

### Contents & Features...

Commonly used as an outlet vent that directs air to a chosen position in a room. Easy to install, this vent is available with 2 different sized rear adaptors for ducting attachment.

- Australian made
- White - Plastic
- Removable grill for easy cleaning



### D6006 150mm White

- Suits 150mm diameter duct
- L270mm x W270mm External dimensions

SKU	Model No.	Description	Barcode	List ea.	Pk. Qty.
	D6006	DIFFUSER EGG-CRATE 6" (150mm)	9317468060066	49.00	6

### D6008 200mm White

- Suits 200mm diameter duct
- L270mm x W270mm External dimensions

SKU	Model No.	Description	Barcode	List ea.	Pk. Qty.
	D6008	DIFFUSER EGG CRATE 8" (200mm)	9317468060080	49.00	6

# VENTS

# OUTLET - CEILING

## Downjet Diffuser

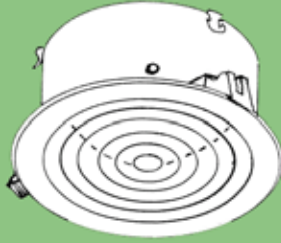

### Contents & Features...

This range of downjet ceiling diffusers evenly disperses air to a chosen area. Simple to install, it comes with spring loaded attachment arms that lock and secure the vent in place. For desired airflow control, push in and turn the central control knob to activate the internal butterfly damper.

- Australian made
- White - Plastic
- Adjustable closure

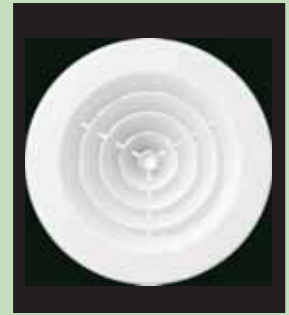

### DJ150 150mm White

- Suits 150mm diameter duct
- 240mm Outer diameter

SKU	Model No.	Description	Barcode	List ea.	Pk. Qty.
	DJ150	DEFLECT-O 150mm DOWNJET OUTLET	9317468681100	30.00	6

### DJ200 200mm White

- Suits 200mm diameter duct
- 290mm Outer diameter

SKU	Model No.	Description	Barcode	List ea.	Pk. Qty.
	DJ200	DEFLECT-O 200mm DOWNJET OUTLET	9317468681117	39.00	6

### DJ250 250mm White

- Suits 250mm diameter duct
- 340mm Outer diameter

SKU	Model No.	Description	Barcode	List ea.	Pk. Qty.
	DJ250	DEFLECT-O 250mm DOWNJET OUTLET	9317468681124	72.00	6

## Euro Style Diffuser



### Contents & Features...

Commonly used as an outlet vent, the design disperses air evenly away from the centre. This is an open style vent with a snap off front grill and flyscreen insert.

- White - Plastic
- Easy installation
- Removable front grill for easy cleaning



### MV100PFS 100mm White

- Suits 100mm diameter duct
- 145mm Outer diameter

SKU	Model No.	Description	Barcode	List ea.	Pk. Qty.
	MV100PFS	ATC CEILING DIFFUSER 100MM	9317468148047	9.40	12

### MV125PFS 125mm White

- Suits 125mm diameter duct
- 170mm Outer diameter

SKU	Model No.	Description	Barcode	List ea.	Pk. Qty.
	MV125PFS	ATC CEILING DIFFUSER 125MM	9317468148054	12.00	12

### MV150PFS 150mm White

- Suits 150mm diameter duct
- 190mm Outer diameter

SKU	Model No.	Description	Barcode	List ea.	Pk. Qty.
	MV150PFS	ATC CEILING DIFFUSER 150MM	9317468148061	14.20	12

### MV200PFS 200mm White

- Suits 200mm diameter duct
- 245mm Outer diameter

SKU	Model No.	Description	Barcode	List ea.	Pk. Qty.
	MV200PFS	ATC CEILING DIFFUSER 200MM	9317468148085	17.50	12

### MV250PFS 250mm White

- Suits 250mm diameter duct
- 300mm Outer diameter

SKU	Model No.	Description	Barcode	List ea.	Pk. Qty.
	MV250PFS	ATC CEILING DIFFUSER 250MM	9317468148108	33.00	12

### MV315PFS 315mm White

- Suits 315mm diameter duct
- 370mm Outer diameter

SKU	Model No.	Description	Barcode	List ea.	Pk. Qty.
	MV315PFS	ATC CEILING DIFFUSER 315MM	9317468148122	42.50	12

# VENTS - RETAIL

# CUPBOARD/DOOR GRILLS

## 6145 Door Grill Set

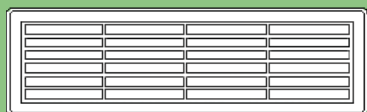

### Contents & Features...

This retail packed, door grill set is supplied with front and rear open style vents that allow for flow through ventilation. The 2 grills simply screw together for door mounting. Ideal for bathrooms with extraction fans or for general ventilation.

- White - ABS Plastic
- 2 x Screws included
- L451mm x W89mm Outer dimensions



SKU	Model No.	Description	Barcode	List ea.	Pk. Qty.
	6145	ATC 435x75 DOOR VENT 2PC SET	9317468061452	21.50	12

## 6150 Single Sided Door Grill Open

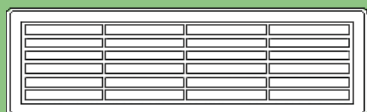

### Contents & Features...

This larger sized, single-sided grill may be coupled with same for flow through door ventilation, or with below model (6150R) for adjustable closure option.

Ideal for bathrooms with extraction fans or for general ventilation.

- White - ABS Plastic
- L465mm x W129mm Outer dimensions
- L430 x W93 x D18mm Rear flange dimensions



SKU	Model No.	Description	Barcode	List ea.	Pk. Qty.
	6150	ATC 435x90 DOOR VENT 1PC OPEN	9317468615006	14.70	12

## 6150R Single Sided Door Grill With Shut Off Slide Control

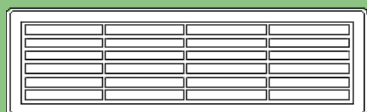

### Contents & Features...

This larger sized, single-sided grill has a simple slide control for airflow adjustment. It may be coupled with above model (6150) for flow through door ventilation.

Ideal for bathrooms with extraction fans or for general ventilation.

- White - ABS Plastic
- Adjustable closure control
- L465mm x W129mm Outer dimensions
- L430 x W92 x D18mm Rear flange dimensions



SKU	Model No.	Description	Barcode	List ea.	Pk. Qty.
	6150R	ATC 435x90 DOOR VENT 1PC OPEN/CLOSE	9317468615013	18.00	12

## MV50/2BVS Round Cupboard Vent



### Contents & Features...

Multi-purpose, push-in round vent with horizontal grills. Superior quality and strength to standard cupboard vents. Ideal breathing holes for appliances such as fridges and clothes dryers enclosed in cabinets and requiring ventilation.

- Flyscreen insert
- White - ABS Plastic
- 60mm Outer diameter
- 48mm Rear flange diameter



SKU	Model No.	Description	Barcode	List ea.	Pk. Qty.
	MV50/2BVS	ATC ROUND VENT W/SCREEN 47MM 2PK. - HORIZ.	9317468148504	6.40	12

## MV51/2BVS Round Cupboard Vent



### Contents & Features...

Multi-purpose, push in, round vent with circular grills. Superior quality and strength to standard cupboard vents. Ideal breathing holes for appliances such as fridges and clothes dryers, enclosed in cabinets and requiring ventilation.

- Flyscreen insert
- White - ABS Plastic
- 60mm Outer diameter
- 48mm Rear flange diameter



SKU	Model No.	Description	Barcode	List ea.	Pk. Qty.
	MV51/2BVS	ATC ROUND VENT W/SCREEN 47MM 2PK. - CIRC.	9317468148511	6.40	12

## SUPURR-FLEX® Metallic Duct

Up To 3.6 Metre Length



### Contents & Features...

Ideally suited for straight venting applications this retail packed range of multi-layered, metallic duct offers superior temperature ratings and flame resistant protection, to all soft-sided ducting competitors.

SUPURR-FLEX® is a multiple use ducting that can be used for exhaust venting of bathrooms, rangehoods, electric clothes dryers and many other applications. Stretch SUPURR-FLEX® ducting taut to gain optimum airflow efficiency.

- Temperature Rating -18°C to +130°C
- Complies with Australian Standards - AS1668.1
- 4 - Zero fire rating to Australian Standards - AS1530.3



### FO408B 100mm x 2.4M

- Suits 100mm venting systems

- L150mm x W102mm Compressed dimensions

SKU	Model No.	Description	Barcode	List ea.	Pk. Qty.
	FO408B	DEFLECTO SUPURR-FLEX DUCT 100MM X 2.4M	079916430485	25.50	6

### FO503M 125mm x 3.6M

- Suits 125mm venting systems

- L175mm x W126mm Compressed dimensions

SKU	Model No.	Description	Barcode	List ea.	Pk. Qty.
	FO503M	DEFLECTO SUPURR-FLEX DUCT 125MM X 3.6M	9317468655033	32.00	6

### FO603M 150mm x 3.6M

- Suits 150mm venting systems

- L175mm x W152mm Compressed dimensions

SKU	Model No.	Description	Barcode	List ea.	Pk. Qty.
	FO603M	DEFLECTO SUPURR-FLEX DUCT 150MM X 3.6M	9317468656030	35.00	6

### FO803M 200mm x 3.6M

- Suits 200mm venting systems

- L200mm x W205mm Compressed dimensions

SKU	Model No.	Description	Barcode	List ea.	Pk. Qty.
	FO803M	DEFLECTO SUPURR-FLEX DUCT 200MM X 3.6M	9317468658034	43.00	6

## SUPURR-FLEX® Metallic Duct

7.6 Metre Length



### Contents & Features...

Ideally suited for straight venting applications this retail packed range of multi-layered, metallic duct offers superior temperature ratings and flame resistant protection, to all soft sided ducting competitors.

SUPURR-FLEX® is a multiple use ducting that can be used for exhaust venting of bathrooms, rangehoods, electric clothes dryers and many other applications. Stretch SUPURR-FLEX® ducting taut to gain optimum airflow efficiency.

- Temperature Rating -18°C to +130°C
- Complies with Australian Standards - AS1668.1
- 4 - Zero fire rating to Australian Standards - AS1530.3



### FUL0425 100mm x 7.6M

- Suits 100mm venting systems

- L450mm x W102mm Compressed dimensions

SKU	Model No.	Description	Barcode	List ea.	Pk. Qty.
	FUL0425	DEFLECTO SUPURR-FLEX DUCT 100MM X 7.6M	079916435015	48.00	6

### FUL0525 125mm x 7.6M

- Suits 125mm venting systems

- L380mm x W210mm Compressed dimensions

SKU	Model No.	Description	Barcode	List ea.	Pk. Qty.
	FUL0525	DEFLECTO SUPURR-FLEX DUCT 125MM X 7.6M	079916435022	60.00	6

### FUL0625 150mm x 7.6M

- Suits 150mm venting systems

- L380mm x W210mm Compressed dimensions

SKU	Model No.	Description	Barcode	List ea.	Pk. Qty.
	FUL0625	DEFLECTO SUPURR-FLEX DUCT 150MM X 7.6M	079916435039	65.00	6

### FUL0825 200mm x 7.6M

- Suits 200mm venting systems

- L400mm x W210mm Compressed dimensions

SKU	Model No.	Description	Barcode	List ea.	Pk. Qty.
	FUL0825	DEFLECTO SUPURR-FLEX DUCT 200MM X 7.6M	079916435053	80.00	6



# DUCTING & ACCESSORIES

# SEMI-RIGID DUCTING

## Semi-Rigid Aluminium 1.4 Metre Length



### Contents & Features...

Supplied in a compressed length this form of flexible ducting has a unique expanding design that offers efficient venting, as it holds it's shape and full diameter, even when bends are applied. Ideal for straight and indirect venting installations for clothes dryers, rangehoods, bathrooms and other general venting applications. To gain maximum length, use both hands to work in sections from the centre - out to either end.

- Retail packed
- Temperature rating -70 °C to +220 °C
- Manufactured material thickness 0.89mm
- Complies with Australian Standards - AS1668.1
- 4 - Zero fire rating to Australian Standards - 1530.3



### A04014MR 100mm x 1.4M

• Suits 100mm venting systems

• L350mm x W109mm Compressed dimensions

SKU	Model No.	Description	Barcode	List ea.	Pk. Qty.
	AO4014MR	DEFLECTO SEMI RIGID ALUM DUCT 100MM X 1.4M	9317468040143	17.00	12

### A05014MR 125mm x 1.4M

• Suits 125mm venting systems

• L350mm x W134mm Compressed dimensions

SKU	Model No.	Description	Barcode	List ea.	Pk. Qty.
	AO5014MR	DEFLECTO SEMI RIGID ALUM DUCT 125MM X1.4M	9317468050142	22.00	12

### A06014MR 150mm x 1.4M

• Suits 150mm venting systems

• L350mm x W160mm Compressed dimensions

SKU	Model No.	Description	Barcode	List ea.	Pk. Qty.
	AO6014MR	DEFLECTO SEMI RIGID ALUM DUCT 150MM X1.4M	9317468060141	25.00	6

## Semi-Rigid Aluminium 3 Metre Length



### Contents & Features...

Supplied in a compressed length this form of flexible ducting has a unique expanding design that offers efficient venting, as it holds it's shape and full diameter, even when bends are applied. Ideal for straight and indirect venting installations for clothes dryers, rangehoods, bathrooms and other general venting applications. To gain maximum length, use both hands to work in sections from the centre - out to either end.

- Retail packed
- Temperature rating -70 °C to +220 °C
- Manufactured material thickness 0.89mm
- Complies with Australian Standards - AS1668.1
- 4 - Zero fire rating to Australian Standards - AS1530.3



### A048MX/9 100mm x 3M

• Suits 100mm venting systems

• L710mm x W109mm Compressed dimensions

SKU	Model No.	Description	Barcode	List ea.	Pk. Qty.
	AO48MX/9	DEFLECTO SEMI RIGID DUCT 100MMX3M + 2CLAMPS	079916424026	36.50	9

### A0403MR 100mm x 3M

• Suits 100mm venting systems

• L710mm x W109mm Compressed dimensions

SKU	Model No.	Description	Barcode	List ea.	Pk. Qty.
	AO403MR	DEFLECTO SEMI RIGID ALUM DUCT 100MM X 3M	9317468004039	34.00	6

### A0503MR 125mm x 3M

• Suits 125mm venting systems

• L710mm x W134mm Compressed dimensions

SKU	Model No.	Description	Barcode	List ea.	Pk. Qty.
	AO503MR	DEFLECTO SEMI RIGID ALUM DUCT 125MM X 3M	9317468005036	42.00	6

### A0603MR 150mm x 3M

• Suits 150mm venting systems

• L710mm x W160mm Compressed dimensions

SKU	Model No.	Description	Barcode	List ea.	Pk. Qty.
	AO603MR	DEFLECTO SEMI RIGID ALUM DUCT 150MM X 3M	9317468006033	49.00	4

### A0803M 200mm x 3M

• Suits 200mm venting systems

• L710mm x W210mm Compressed dimensions

SKU	Model No.	Description	Barcode	List ea.	Pk. Qty.
	AO803M	DEFLECTO SEMI RIGID ALUM DUCT 200MM X 3M BULK	079916424095	65.00	4

# DUCTING & ACCESSORIES

# SEMI-RIGID DUCTING

## Heavy Duty Semi-Rigid Aluminium 1.4 Metre Length



### Contents & Features...

30% Thicker material is used in manufacturing to offer greater strength and temperature rating.

Supplied in a compressed length this form of flexible ducting has a unique expanding design that offers efficient venting, as it holds its shape and full diameter, even when bends are applied.

Ideal for straight and indirect venting installations for clothes dryers, rangehoods, bathrooms and other general venting applications.

To gain maximum length, use both hands to work in sections from the centre - out to either end.

- Retail packed
- Temperature rating -70°C to +250°C
- Manufactured material thickness 1.20mm
- 4 - Zero fire rating to Australian Standards
- Exceeds Australian Standards - AS1530.3 & AS1668.1

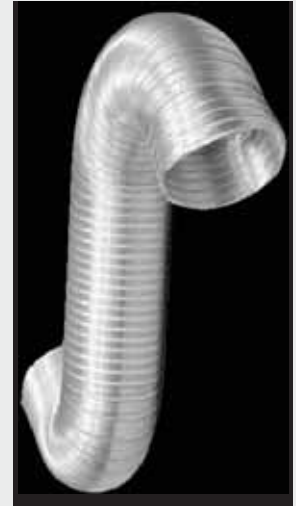

### A04014HDR 100mm x 1.4M

- Suits 100mm venting systems

- L360mm x W110mm Compressed dimensions

SKU	Model No.	Description	Barcode	List ea.	Pk. Qty.
	AO4014HDR	DEFLECTO SEMI RIGID H/DUTY DUCT 100MM X1.4M	9317468740142	22.50	12

### A05014HDR 125mm x 1.4M

- Suits 125mm venting systems

- L350mm x W135mm Compressed dimensions

SKU	Model No.	Description	Barcode	List ea.	Pk. Qty.
	AO5014HDR	DEFLECTO SEMI RIGID H/DUTY DUCT 125MM X1.4M	9317468750141	27.50	12

### A06014HDR 150mm x 1.4M

- Suits 150mm venting systems

- L350mm x W161mm Compressed dimensions

SKU	Model No.	Description	Barcode	List ea.	Pk. Qty.
	AO6014HDR	DEFLECTO SEMI RIGID H/DUTY DUCT 150MM X1.4M	9317468760140	31.00	12

## Heavy Duty Semi-Rigid Aluminium 3 Metre Length



### Contents & Features...

30% Thicker material is used in manufacturing to offer greater strength and temperature rating.

Supplied in a compressed length this form of flexible ducting has a unique expanding design that offers efficient venting, as it holds its shape and full diameter, even when bends are applied.

Ideal for straight and indirect venting installations for clothes dryers, rangehoods, bathrooms and other general venting applications.

To gain maximum length, use both hands to work in sections from the centre - out to either end.

- Retail packed
- Temperature rating -70°C to +250°C
- Manufactured material thickness 1.20mm
- 4 - Zero fire rating to Australian Standards
- Exceeds Australian Standards - AS1530.3 & AS1668.1



### A0403HDR 100mm x 3M

- Suits 100mm venting systems

- L720mm x W110mm Compressed dimensions

SKU	Model No.	Description	Barcode	List ea.	Pk. Qty.
	AO403HDR	DEFLECTO SEMI RIGID H/DUTY DUCT 100MM X 3M	9317468014038	43.00	6

### A0503HDR 125mm x 3M

- Suits 125mm venting systems

- L720mm x W135mm Compressed dimensions

SKU	Model No.	Description	Barcode	List ea.	Pk. Qty.
	AO503HDR	DEFLECTO SEMI RIGID H/DUTY DUCT 125MM X 3M	9317468015035	52.00	6

### A0603HDR 150mm x 3M

- Suits 150mm venting systems

- L720mm x W161mm Compressed dimensions

SKU	Model No.	Description	Barcode	List ea.	Pk. Qty.
	AO603HDR	DEFLECTO SEMI RIGID H/DUTY DUCT 150MM X 3M	9317468016032	60.00	6

# DUCTING & ACCESSORIES

# INSULATED DUCTING

## Insulated Duct 3 Metre Length



### Contents & Features...

Polyester laminated, silver/black core coupled with polyester insulation and white, polythene sleeve that has been treated with anti-oxidant and UV stabilisers.

Suitable for ducted heating and cooling installations.

- Fire rated
- Supplied compressed in plastic bags
- Made in Australia to Australian Standards
- Matches with all boots, branch take-offs of same diameter

\*Hint - Keep internal ducting taut for maximum airflow efficiency.



### D603M 150mm x 3M

- Suits 150mm ducting systems
- 220mm External diameter

SKU	Model No.	Description	Barcode	List ea.	Pk. Qty.
	D603M	FIRE RATED INSULATED DUCT 6" x 3M	9317468606035	36.50	6

### D803M 200mm x 3M

- Suits 200mm ducting systems
- 270mm External diameter

SKU	Model No.	Description	Barcode	List ea.	Pk. Qty.
	D803M	FIRE RATED INSULATED DUCT 8" x 3M	9317468608039	47.00	6

### D1003M 250mm x 3M

- Suits 250mm ducting systems
- 320mm External diameter

SKU	Model No.	Description	Barcode	List ea.	Pk. Qty.
	D1003M	FIRE RATED INSULATED DUCT 10" X 3M	9317468610032	65.00	6

### D1203M 300mm x 3M

- Suits 300mm ducting systems
- 370mm External diameter

SKU	Model No.	Description	Barcode	List ea.	Pk. Qty.
	D1203M	FIRE RATED INSULATED DUCT 12" X 3M	9317468612036	70.00	6

## Insulated Duct 6 Metre Length



### Contents & Features...

Polyester laminated, silver/black core coupled with polyester insulation and white, polythene sleeve that has been treated with anti-oxidant and UV stabilisers.

Suitable for ducted heating and cooling installations.

- Fire rated
- Supplied compressed in plastic bags
- Made in Australia to Australian Standards
- Matches with all boots, branch take-offs of same diameter

\*Hint - Keep internal ducting taut for maximum airflow efficiency.



### D606M 150mm x 6M

- Suits 150mm ducting systems
- 220mm External diameter

SKU	Model No.	Description	Barcode	List ea.	Pk. Qty.
	D606M	FIRE RATED INSULATED DUCT 6" x 6M	9317468606066	70.00	6

### D806M 200mm x 6M

- Suits 200mm ducting systems
- 270mm External diameter

SKU	Model No.	Description	Barcode	List ea.	Pk. Qty.
	D806M	FIRE RATED INSULATED DUCT 8" x 6M	9317468608060	90.00	6

### D1006M 250mm x 6M

- Suits 250mm ducting systems
- 320mm External diameter

SKU	Model No.	Description	Barcode	List ea.	Pk. Qty.
	D1006M	FIRE RATED INSULATED DUCT 10" X 6M	9317468610063	116.00	6

### D1206M 300mm x 6M

- Suits 300mm ducting systems
- 370mm External diameter

SKU	Model No.	Description	Barcode	List ea.	Pk. Qty.
	D1206M	FIRE RATED INSULATED DUCT 12" X 6M	9317468612067	140.00	6

# DUCTING & ACCESSORIES

# CLAMPS

## DIY Stainless Steel Worm Drive Clamping System

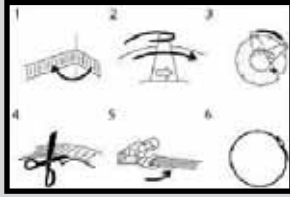

### Contents & Features...

- 30 Metre continuous stainless steel worm drive band
- Separate galvanised and stainless steel locking mechanism allows any size band to be made up on site
- Eliminates the need to carry a lot of various sized clamps
- Quick and easy system
- Ideal for all trades and services



## CRA Clamps on a Roll



- 30M x 9mm x 0.6mm Roll of stainless steel band in pre-calibrated ABS dispenser
- Stainless steel AISI 430
- Use with SCA - Clamp locking device



SKU	Model No.	Description	Barcode	List ea.	Pk. Qty.
	CRA	ATC S/S CLAMP BAND ON ROLL - 30m	9317468779166	64.00	10

## SCA Clamp Locking Device



- For use with CRA - Clamps on a roll
- Upper and lower housing: Low carbon steel nickel plated
- Locking mechanism: Stainless steel AISI 430
- Screw: 7mm cross slotted hex head in galvanised steel
- Packing: Box of 50 in 2 bags of 25



SKU	Model No.	Description	Barcode	List ea.	Pk. Qty.
	SCA	ATC S/S CLAMP BAND LOCKING SCREWS - 50/PK	9317468779173	64.00	10

## Metal Worm Drive Clamps



### Contents & Features...

Made from zinc plated steel, these metal worm drive clamps are the most professional way to secure any ducting.

Eliminates the use of tape or cable ties that overtime, can become loose with excessive air pressures, temperatures or condensation.

To use - Simply loosen the clamp with a flat blade screwdriver or 1/4" hex driver, slip the clamp over the ducting, position correctly and tighten screw firmly in a clockwise direction.

To remove - Simply rotate the screw in an anti-clockwise direction.



**MC4/2 100mm** • Suits 100mm diameter ducting • Retail packed in a quantity of 2

SKU	Model No.	Description	Barcode	List ea.	Pk. Qty.
	MC4/2	DEFLECTO WORM DRIVE DUCT CLAMP 100MM 2PK	9317468671446	6.50	12

**MC5/2 125mm** • Suits 125mm diameter ducting • Retail packed in a quantity of 2

SKU	Model No.	Description	Barcode	List ea.	Pk. Qty.
	MC5/2	DEFLECTO WORM DRIVE DUCT CLAMP 125MM 2PK	9317468671453	7.90	12

**MC6/2 150mm** • Suits 150mm diameter ducting • Retail packed in a quantity of 2

SKU	Model No.	Description	Barcode	List ea.	Pk. Qty.
	MC6/2	DEFLECTO WORM DRIVE DUCT CLAMP 150MM 2PK	9317468671460	9.00	12

**MC8/2 200mm** • Suits 200mm diameter ducting • Retail packed in a quantity of 2

SKU	Model No.	Description	Barcode	List ea.	Pk. Qty.
	MC8/2	DEFLECTO WORM DRIVE DUCT CLAMP 200MM 2PK	9317468671385	12.50	12



# DUCTING & ACCESSORIES

# INCREASERS & ELBOWS

## Increasers/Reducers Galvanised Steel



### Contents & Features...

Designed in gradual-staged sections to minimise backflow pressures when reducing diameters.  
Made in galvanised steel for protection against fire and corrosion.



### DIRB54 100 - 125mm

- Joins 100mm to 125mm duct

- L150mm External dimensions

SKU	Model No.	Description	Barcode	List ea.	Pk. Qty.
	DIRB54	DEFLECTO DUCT INCREASER 100 -125MM GALV	079916908229	15.00	12

### DIRB65 125 - 150mm

- Joins 125mm to 150mm duct

- L150mm External dimensions

SKU	Model No.	Description	Barcode	List ea.	Pk. Qty.
	DIRB65	DEFLECTO DUCT INCREASER 125 -150MM GALV	079916908250	24.00	12

### DIRB86 150 - 200mm

- Joins 150mm to 200mm duct

- L180mm External dimensions

SKU	Model No.	Description	Barcode	List ea.	Pk. Qty.
	DIRB86	DEFLECTO DUCT INCREASER 150 -200MM GALV	079916908281	34.00	12

## Adjustable Elbows 0-90° Galvanised Steel



### Contents & Features...

Clever by design - each sections rotates to create various shapes and angles. Use in conjunction with clip-seam piping - **see over**.  
Made in 30g.Galv. steel for protection against fire and corrosion.



### ELB049030 100mm

- Suits 100mm diameter ducting

- 1 x Crimped end for duct extension fitting

SKU	Model No.	Description	Barcode	List ea.	Pk. Qty.
	ELB049030	DEFLECTO ADJUST ELBOW 0-90DEG 100MM GALV	079916901812	16.00	6

### ELB059030 125mm

- Suits 125mm diameter ducting

- 1 x Crimped end for duct extension fitting

SKU	Model No.	Description	Barcode	List ea.	Pk. Qty.
	ELB059030	DEFLECTO ADJUST ELBOW 0-90DEG 125MM GALV	079916901824	27.00	6

### ELB069030 150mm

- Suits 150mm diameter ducting

- 1 x Crimped end for duct extension fitting

SKU	Model No.	Description	Barcode	List ea.	Pk. Qty.
	ELB069030	DEFLECTO ADJUST ELBOW 0-90DEG 150MM GALV	079916901831	34.00	6

### ELB089030 200mm

- Suits 200mm diameter ducting

- 1 x Crimped end for duct extension fitting

SKU	Model No.	Description	Barcode	List ea.	Pk. Qty.
	ELB089030	DEFLECTO ADJUST ELBOW 0-90DEG 200MM GALV	079916901855	43.00	6

### ELB109030 250mm

- Suits 250mm diameter ducting

- 1 x Crimped end for duct extension fitting

SKU	Model No.	Description	Barcode	List ea.	Pk. Qty.
	ELB109030	DEFLECTO ADJUST ELBOW 0-90DEG 250MM GALV	079916901879	78.00	6

## Adjustable Elbows 0-90° Aluminium



### Contents & Features...

Clever by design - each sections rotates to create various shapes and angles. Use in conjunction with clip-seam piping - **see over**.  
Made in 0.64mm Alum. for protection against fire and corrosion.



### AELB049025 100mm

- Suits 100mm diameter ducting

- 1 x Crimped end for duct extension fitting

SKU	Model No.	Description	Barcode	List ea.	Pk. Qty.
	AELB049025	DEFLECTO ADJUST ELBOW 0-90DEG 100MM ALUM	079916902845	25.00	6

### AELB059025 125mm

- Suits 125mm diameter ducting

- 1 x Crimped end for duct extension fitting

SKU	Model No.	Description	Barcode	List ea.	Pk. Qty.
	AELB059025	DEFLECTO ADJUST ELBOW 0-90DEG 125MM ALUM	079916902852	30.00	6

### AELB069025 150mm

- Suits 150mm diameter ducting

- 1 x Crimped end for duct extension fitting

SKU	Model No.	Description	Barcode	List ea.	Pk. Qty.
	AELB069025	DEFLECTO ADJUST ELBOW 0-90DEG 150MM ALUM	079916902869	35.00	6

## "Clip-Seam" Solid Duct

**Galvanised**  
**610mm Length**

REEVES SNAPLOCK



## Contents & Features...

Made from 30 gauge, galvanised steel - this unique "Clip-Seam" ducting offers the convenience of compact storage and economical transporting by nesting inside each other.

Once on site, insert the two seams together at one end and work up the length to form a solid pipe.

- Use with mushroom cowl as roof penetration pipe - Refer page 39



**GSPS042430**

**100mm**

- Suits 100mm venting systems

- 1 x Crimped end for duct extension fitting

SKU	Model No.	Description	Barcode	List ea.	Pk. Qty.
	GSPS042430	DEFLECTO CLIP-SEAM PIPE 100MM X 610MM GALV	079916901152	13.50	10

**GSPS052430**

**125mm**

- Suits 125mm venting systems

- 1 x Crimped end for duct extension fitting

SKU	Model No.	Description	Barcode	List ea.	Pk. Qty.
	GSPS052430	DEFLECTO CLIP-SEAM PIPE 125MM X 610MM GALV	079916930008	16.00	10

**GSPS062430**

**150mm**

- Suits 150mm venting systems

- 1 x Crimped end for duct extension fitting

SKU	Model No.	Description	Barcode	List ea.	Pk. Qty.
	GSPS062430	DEFLECTO CLIP-SEAM PIPE 150MM X 610MM GALV	079916901169	18.00	10

## "Clip-Seam" Solid Duct

**Galvanised**  
**1530mm Length**

REEVES SNAPLOCK

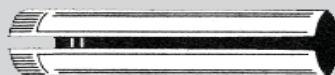

## Contents & Features...

Made from 30 gauge, galvanised steel - this unique "Clip-Seam" ducting offers the convenience of compact storage and economical transporting by nesting inside each other.

Once on site, insert the two seams together at one end and work up the length to form a solid pipe.

- Use with mushroom cowl as roof penetration pipe - Refer page 39



**PPX04530**

**100mm**

- Suits 100mm venting systems

- 1 x Crimped end for duct extension fitting

SKU	Model No.	Description	Barcode	List ea.	Pk. Qty.
	PPX04530	DEFLECTO CLIP-SEAM PIPE 100MM X 1530MM GALV	9317468045308	26.00	5

**PPX05530**

**125mm**

- Suits 125mm venting systems

- 1 x Crimped end for duct extension fitting

SKU	Model No.	Description	Barcode	List ea.	Pk. Qty.
	PPX05530	DEFLECTO CLIP-SEAM PIPE 125MM X 1530MM GALV	9317468055307	29.50	5

**PPX06530**

**150mm**

- Suits 150mm venting systems

- 1 x Crimped end for duct extension fitting

SKU	Model No.	Description	Barcode	List ea.	Pk. Qty.
	PPX06530	DEFLECTO CLIP-SEAM PIPE 150MM X 1530MM GALV	9317468065306	35.00	5

## "Clip-Seam" Solid Duct

**Aluminium**  
**915mm Length**

REEVES SNAPLOCK



## Contents & Features...

Manufactured in 0.64mm aluminium, this "Clip-Seam" ducting offers the convenience and economics as above piping.

Once on site, insert the two seams together at one end and work up the length to form a solid pipe.

- Use with mushroom cowl as roof penetration pipe - Refer page 39



**ASP043625**

**100mm**

- Suits 100mm venting systems

- 1 x Crimped end for duct extension fitting

SKU	Model No.	Description	Barcode	List ea.	Pk. Qty.
	ASP043625	DEFLECTO ALUM SEAM PIPE 100MM X 915MM	079916902760	25.50	10

**ASP053622**

**125mm**

- Suits 125mm venting systems

- 1 x Crimped end for duct extension fitting

SKU	Model No.	Description	Barcode	List ea.	Pk. Qty.
	ASP053622	DEFLECTO ALUM SEAM PIPE 125MM X 915MM	079916902746	30.00	10

**ASP063625**

**150mm**

- Suits 150mm venting systems

- 1 x Crimped end for duct extension fitting

SKU	Model No.	Description	Barcode	List ea.	Pk. Qty.
	ASP063625	DEFLECTO ALUM SEAM PIPE 150MM X 915MM	079916902784	35.00	10

# DUCTING & ACCESSORIES

# DRAFT BLOCKERS

## Draft Blocker Galvanised Steel



### Contents & Features...

Manufactured with an internally, spring-loaded butterfly damper that allows air to flow through in one direction and close when the venting system is not in use.

These in-line draft blockers are ideally installed in vertical venting systems such as rangehoods, exhausting out through the roof.

\*Hint - Maintain at regular intervals to ensure there is no blockage.

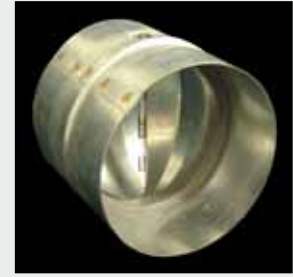

**OKA100**      **100mm**      • Suits 100mm diameter ducting      • L88mm x W100mm External dimensions

SKU	Model No.	Description	Barcode	List ea.	Pk. Qty.
	OKA100	ATC DUCT CONNECT W/BACK VALVE 100MM STEEL	9317468201001	25.00	6

**OKA125**      **125mm**      • Suits 125mm diameter ducting      • L88mm x W125mm External dimensions

SKU	Model No.	Description	Barcode	List ea.	Pk. Qty.
	OKA125	ATC DUCT CONNECT W/BACK VALVE 125MM STEEL	9317468201254	29.50	6

**OKA150**      **150mm**      • Suits 150mm diameter ducting      • L88mm x W150mm External dimensions

SKU	Model No.	Description	Barcode	List ea.	Pk. Qty.
	OKA150	ATC DUCT CONNECT W/BACK VALVE 150MM STEEL	9317468201506	34.00	6

**OKA200**      **200mm**      • Suits 200mm diameter ducting      • L88mm x W200mm External dimensions

SKU	Model No.	Description	Barcode	List ea.	Pk. Qty.
	OKA200	ATC DUCT CONNECT W/BACK VALVE 200MM STEEL	9317468202008	41.00	6

## BD04 100mm Plastic



This 100mm draft blocker is manufactured in the USA, and comes complete with a surrounding mounting plate that can be attached to the wall or ceiling.

The internal gravity damper is pivot mounted and allows air to pass through in one direction only.

- Most effective in a horizontal venting installation.

\*Hint - Maintain at regular intervals to ensure there is no blockage.

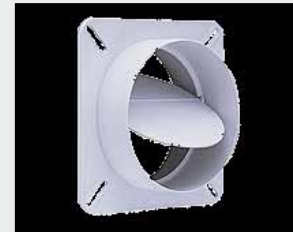

SKU	Model No.	Description	Barcode	List ea.	Pk. Qty.
	BD04	DEFLECTO COLD DRAFT BLOCKER 100MM PLASTIC	079916500706	19.00	6

## Draft Blocker Plastic

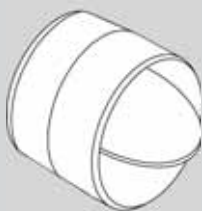

### Contents & Features...

Made from fire retardant plastic, these inline draft blockers have an internal gravity damper that is pivot mounted to allow for one-way airflow.

Being lightweight, they still allow for efficient venting whilst resisting back drafts when a system is not in operation.

- May be used in a vertical or horizontal venting system

\*Hint - Maintain at regular intervals to ensure there is no blockage.



**V1111**      **100mm**      • Suits 100mm diameter ducting      • L60mm x W100mm External dimensions

SKU	Model No.	Description	Barcode	List ea.	Pk. Qty.
	V1111	ATC DUCT CONNECT W/BACK VALVE 100MM PLASTIC	9317468011112	10.50	12

**V2121**      **125mm**      • Suits 125mm diameter ducting      • L60mm x W125mm External dimensions

SKU	Model No.	Description	Barcode	List ea.	Pk. Qty.
	V2121	ATC DUCT CONNECT W/BACK VALVE 125MM PLASTIC	9317468021210	13.50	12

**V3131**      **150mm**      • Suits 150mm diameter ducting      • L60mm x W150mm External dimensions

SKU	Model No.	Description	Barcode	List ea.	Pk. Qty.
	V3131	ATC DUCT CONNECT W/BACK VALVE 150MM PLASTIC	9317468031318	18.00	12

# DUCTING & ACCESSORIES

# DUCT CONNECTORS

## Duct Connectors



### Contents & Features...

Made in Australia, this range of duct connecting sleeves are used to extend the length of a venting application.

Manufactured in galvanised steel for protection against fire and corrosion.

Use to connect 2 pieces of Semi-Rigid or SUPURR-FLEX® ducting.

Simply, place a matching size metal worm drive clamp over the end of the ducting, insert one end of the sleeve into the ducting, position the clamp and tighten.

Do the same for the other side.



### DAC4

**100mm**

• Suits 100mm diameter ducting

• L110mm x W100mm External dimensions

SKU	Model No.	Description	Barcode	List ea.	Pk. Qty.
	DAC4	DEFLECTO DUCT CONNECT SLEEVE 100MM	079916200101	8.50	6

### DAC5

**125mm**

• Suits 125mm diameter ducting

• L110mm x W125mm External dimensions

SKU	Model No.	Description	Barcode	List ea.	Pk. Qty.
	DAC5	DEFLECTO DUCT CONNECT SLEEVE 125MM	079916931555	9.90	6

### DAC6

**150mm**

• Suits 150mm diameter ducting

• L110mm x W150mm External dimensions

SKU	Model No.	Description	Barcode	List ea.	Pk. Qty.
	DAC6	DEFLECTO DUCT CONNECT SLEEVE 150MM	079916202027	11.90	6

### DAC8

**200mm**

• Suits 200mm diameter ducting

• L150mm x W200mm External dimensions

SKU	Model No.	Description	Barcode	List ea.	Pk. Qty.
	DAC8	DEFLECTO DUCT CONNECT SLEEVE 200MM	079916200224	16.50	6

## NOTES

---

---

---

---

---

---

---

---

---

---

---

---

---

---

---

---

---

---

---

---

---

---

---

---



Model	Page	Model	Page	Model	Page	Model	Page
40	32	D1003M	46	D235	29	DMR1217	30
50	32	D1006M	46	D236	29	DMR1218	30
51	32	D10108	34	D237	29	DMR1226	30
67	32	D1088	33	D238	29	DMR1228	30
99	32	D1203M	46	D239	29	DMR1239	30
6145	42	D1206M	46	D240	29	DMR1244	30
6150	42	D121010	34	D301	33	DMR1249	30
6150R	42	D121210	34	D302	33	DMR1253	30
AELB049025	48	D201	28	D303	33	DMR1256	30
AELB059025	48	D202	28	D304	33	DMR1259	30
AELB069025	48	D203	28	D6006	40	DV4A	19
AO4014HDR	45	D204	28	D6008	40	DVS1	17
AO4014MR	44	D205	28	D603M	46	DVS2	16
AO403HDR	45	D206	28	D606M	46	DVS3	16
AO403MR	44	D207	28	D803M	46	DVS4	17
AO48MX/9	44	D208	28	D806M	46	DVS5	16
AO5014HDR	45	D209	28	D866	33	DVS6	17
AO5014MR	44	D210	28	D886	33	DVSA	18
AO503HDR	45	D211	28	DAC4	51	DVSC	18
AO503MR	44	D212	28	DAC5	51	DVSD	18
AO6014HDR	45	D213	28	DAC6	51	DVSE	18
AO6014MR	44	D214	28	DAC8	51	DVSI	18
AO603HDR	45	D215	28	DAF2	22	DVSO	18
AO603MR	44	D216	28	DAF3	22	DVSS100	37
AO803M	44	D217	28	DAIW	22	DVSS125	37
ASP043625	49	D218	28	DB4K	21	DVSS150	37
ASP053622	49	D219	28	DF150	25	DVSSC	19
ASP063625	49	D220	28	DF200	25	DVSU	19
BD04	50	D221	29	DF250	25	DVSWI	19
BV01	27	D222	29	DIAT150	24	DVSWO	19
BV02	27	D223	29	DIAT150I	24	DVSWP	19
BV04	27	D224	29	DIAT200	24	DY1088	33
BV05	27	D225	29	DIAT200I	24	DY866	33
BV06	27	D226	29	DIRB54	48	ELB049030	48
BV08	27	D227	29	DIRB65	48	ELB059030	48
BV09	27	D228	29	DIRB86	48	ELB069030	48
BV10	27	D229	29	DJ150	41	ELB089030	48
CD150	40	D230	29	DJ200	41	ELB109030	48
CD200	40	D231	29	DJ250	41	EVE	39
CD250	40	D232	29	DK4W	21	EVSS100	37
CD300	40	D233	29	DMR1203	30	EVSS125	37
CRA	47	D234	29	DMR1213	30	EVSS150	37

Model	Page	Model	Page	Model	Page	Model	Page
EVSS200	37	MV100BVS	39	REG164HB	31	RHA125E	7
FO408B	43	MV100PFS	41	REG164PR	31	RHA125R	6
FO503M	43	MV100VS	38	REG164SB	31	RHA125T	5
FO603M	43	MV120VS	38	REG164WB	31	RHA125W	8
FO803M	43	MV125BVS	39	REG164WH	31	RHA5	4
FUL0425	43	MV125PFS	41	RF125E	13	RHF5R	4
FUL0525	43	MV150BVS	39	RF125R	12	RHF6R	4
FUL0625	43	MV150PFS	41	RF125T	12	RHK125E	7
FUL0825	43	MV150VS	38	RF125W	13	RHK125R	6
GSPS042430	49	MV200	35	RF150E	13	RHK125T	5
GSPS052430	49	MV200PFS	41	RF150T	12	RHK125W	8
GSPS062430	49	MV250PFS	41	RF150W	13	RHK150E	10
GVSS100	36	MV315PFS	41	RF41203	26	RHK150T	9
GVSS125	36	MV50/2BVS	42	RF41213	26	RHK150W	11
GVSS150	36	MV51/2BVS	42	RF41217	26	RMC4	39
GVSS200	36	OKA100	50	RF41218	26	RMC5	39
HS7W	35	OKA125	50	RF41226	26	RMC6	39
HSM4BR	38	OKA150	50	RF41228	26	SCA	47
HSM4WR	38	OKA200	50	RF41239	26	SK8WA	20
HSM5BR	38	PPX04530	49	RF41244	26	SK8WF	20
HSM5WR	38	PPX05530	49	RF41249	26	SVHCW4	20
HSM6BR	38	PPX06530	49	RF41253	26	SVHCW4F	20
HSM6WR	38	RCT	39	RF41256	26	TFG4	40
HSR4B	35	REG146	31	RF41259	26	TFG6	40
HSR4W	35	REG146AC	31	RFA125E	13	V1111	50
HSR5B	35	REG146AS	31	RFA125R	12	V2121	50
HSR5W	35	REG146BL	31	RFA125T	12	V3131	50
HSR6B	35	REG146BS	31	RFA125W	13	VKC5605	14
HSR6W	35	REG146CH	31	RFK125E	13	VKC5606	14
HVSS100	36	REG146GR	31	RFK125R	12	VKC5608	14
HVSS125	36	REG146HB	31	RFK125T	12	VKC5612	14
HVSS150	36	REG146PR	31	RFK125W	13	VKC5613	14
LF20405	14	REG146SB	31	RFK150E	13	VKC5616	15
LF20410	14	REG146WB	31	RFK150T	12	VKC5626	15
LR150E	23	REG146WH	31	RFK150W	13	VKC5630	15
LR150W	23	REG164	31	RH125E	7	VKC5631BE	15
LTF	21	REG164AC	31	RH125R	6	VKC5631BR	15
LTKA	21	REG164AS	31	RH125T	5	VKC5631T	15
MC4/2	47	REG164BL	31	RH125W	8	VKC5631W	15
MC5/2	47	REG164BS	31	RH150E	10		
MC6/2	47	REG164CH	31	RH150T	9		
MC8/2	47	REG164GR	31	RH150W	11		









Proud Distributors of the Following Leading Brands...



### Australia

JPM International Pty Ltd  
21 Research Drive  
Croydon Victoria 3136  
Australia

Phone: (03) 9761 6250  
Freecall: 1800 338 574  
Facsimile: (03) 9761 6226  
Email: info@jpmark.com.au

### New Zealand

JPM New Zealand Ltd  
37A Richards Avenue  
Forest Hill Auckland  
New Zealand

Phone: +64 9 410 3366  
Facsimile: 64 9 410 0199  
Email: sales@larstons.co.nz  
Web: www.larstons.co.nz

Proudly Distributed By:



[www.jpmark.com.au](http://www.jpmark.com.au)